

H
O
R
E
C
A

abert

CATALOGO 2024

STORIA STORIA

STORIA

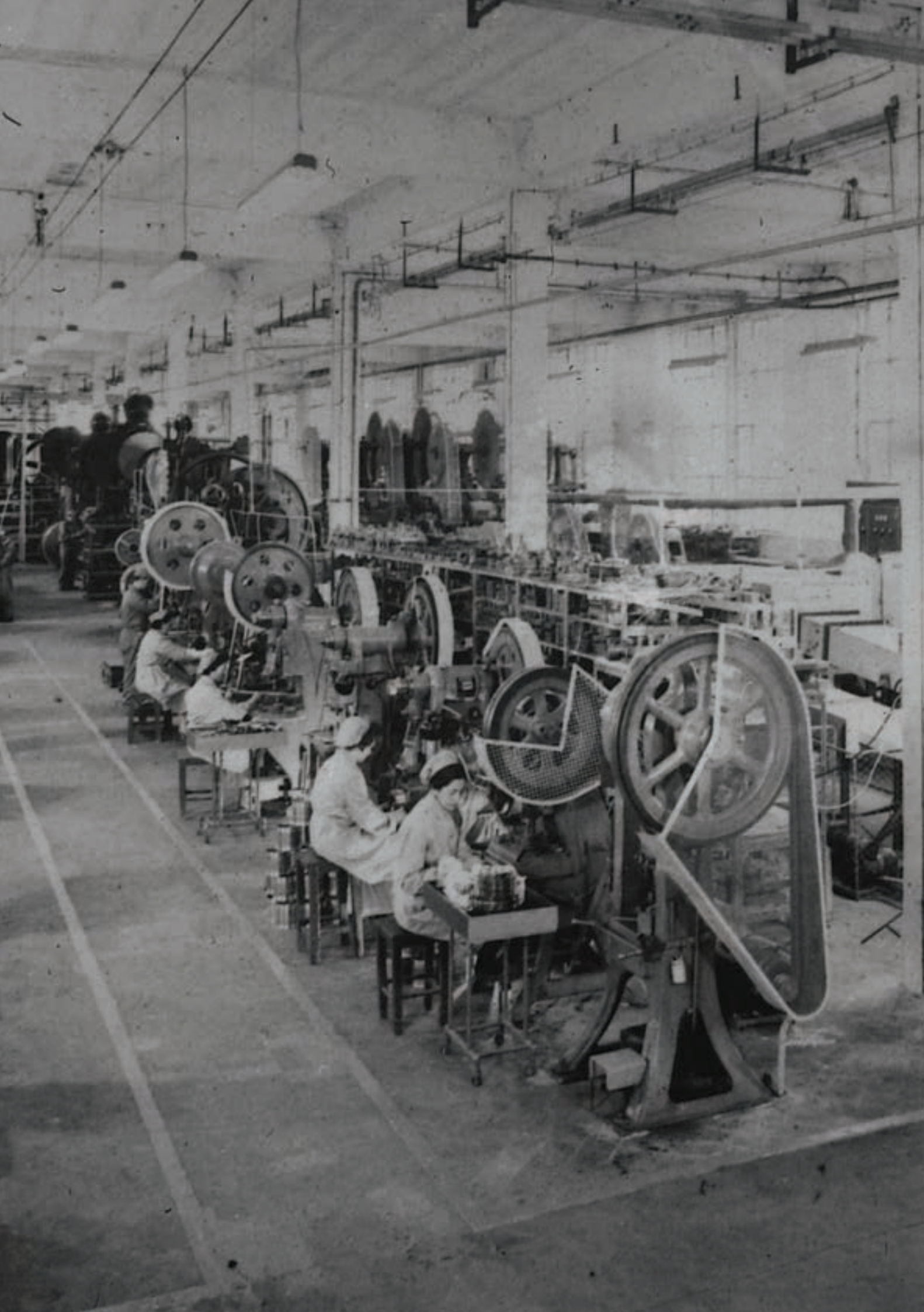

INTRODUZIONE

LEADER NEL SETTORE DELLA POSATERIA, NEGLI ACCESSORI PER LA TAVOLA E NEI PRODOTTI HO.RE.CA.

DAL 1929 Abert si è distinta per la sua abilità nell'interpretazione del mercato, la consapevolezza ambientale e l'etica nel lavoro e nelle relazioni sociali.

Icona di eccellente QUALITÀ, forte della sua ESPERIENZA nel MADE-IN-ITALY, Abert è anche sinonimo di costante apertura a tutto ciò che è INNOVAZIONE ed attualità.

Il CORE BUSINESS dell'azienda è la produzione ed il mercato di POSATE A MARCHIO ABERT, che si caratterizzano in linee dal differente posizionamento commercializzate in diversi canali di distribuzione.

Nell'ultimo decennio, il portfolio prodotti è stato integrato con ARTICOLI PER LA TAVOLA, LA CUCINA E LA COTTURA fornita da PROMAB ed a partire dal 2015, con i PRODOTTI IN CERAMICA VISTA ALEGRE.

I NOSTRI NUMERI

LEADER NEL MERCATO ITALIANO, EXPORT IN PIÙ DI 80 PAESI

140 dipendenti circa

2 aree produttive situate a Passirano (BS), Italia:

- 10.000 m2 dedicati alla produzione e lucidatura

- 21.000 m2 dedicati al confezionamento e stoccaggio

1 area produttiva situata a Lumezzane (BS), Italia:

- 6.700 m2 dedicati alla produzione e lucidatura

Capacità di produzione posate: 40 MILIONI PEZZI/ANNO

I NOSTRI PUNTI DI FORZA

ECCELLENTE QUALITÀ garantita da:

- KNOW-HOW
- GARANZIA per ogni prodotto
- CERTIFICAZIONE ISO 9001

MADE IN ITALY nel rispetto dei diritti e della sicurezza dei lavoratori, dell'ambiente e della creatività italiana.

FLESSIBILITÀ E PERSONALIZZAZIONE per soddisfare ogni necessità del cliente.

Alto livello di SERVIZIO nella gestione di qualsiasi ordine.

VASTA GAMMA di prodotti che copre tutti i posizionamenti (medio, medio/alto, alto) in ogni canale di distribuzione.

PERCHÈ SCEGLIERCI

PROPOSTA COMPLETA E INTEGRATA: dalle posate, agli articoli professionali, ai complementi tavola e cucina ALTA QUALITÀ dei prodotti.

Massima possibilità di PERSONALIZZAZIONE dei prodotti e dei servizi.

AFFIDABILITÀ E CONTINUITÀ degli assortimenti.

PRESENZA CAPILLARE sul territorio e grande attenzione al servizio al cliente.

RAPIDITÀ NELLA GESTIONE dell'ordine e nella consegna, grazie all'informatizzazione dei processi, ad un livello di scorta costante e ad un magazzino automatizzato.

INTRODUCTION

LEADER IN THE CUTLERY SECTOR, TABLE ACCESSORIES AND HO.RE.CA. PRODUCTS

SINCE 1929 Abert has distinguished itself by its ability in interpreting the market, environmental awareness and ethics in business and social relationships.

Symbol of QUALITY excellence, MADE-IN-ITALY consolidated EXPERIENCE and constant opening to all that is INNOVATIVE AND TRENDY.

The CORE BUSINESS is the production and marketing of ABERT and BROGGI branded CUTLERY, which differ for positioning and distribution channels.

In the last decade, the product portfolio has been integrated with PROMAB KITCHEN BRANDED PRODUCTS, and from 2015 with VISTA ALEGRE, Portuguese PORCELAIN PRODUCER.

FACTS & FIGURES

LEADER IN THE ITALIAN MARKET

EXPORTS IN OVER 80 COUNTRIES

140 employees

2 industrial sites located in Passirano (BS), Italy

- 10.000 m2 dedicated to production and polishing

- 21.000 m2 dedicated to packaging and warehousing

1 industrial site based in Lumezzane (BS), Italy:

- 6.700 m2 dedicated to the production and polishing

Cutlery production capacity: 40 MILLION PCS/YEAR

OUR STRENGTHS

EXCELLENT QUALITY guaranteed by:

- KNOW-HOW derived by Abert and Broggi tradition
- WARRANTY for all products
- ISO 9001 CERTIFICATION

MADE-IN-ITALY production, in respect to the rights and safety of workers, to the environment and devoted to the Italian creativity.

FLEXIBILITY & PERSONALIZATION to satisfy any need, thanks to customization capability (design, finishing, décor).

HIGH SERVICE level in managing orders, thanks to the level of stocks, automated warehouses and high responsiveness.

WIDE AND COMPLETE RANGE of products covering all positioning (medium, medium/high, high) in each distribution channel.

WHY US

COMPLETE AND INTEGRATED COLLECTION: cutlery, professional items for the ho.re.ca. market, kitchen and table accessories.

Products HIGH QUALITY.

EXTENSIVE CUSTOMIZATION options of products and services.

RELIABILITY and assortment CONTINUITY.

WIDESPREAD COVERAGE on the territory and great focus on customer service.

FAST ORDER MANAGEMENT AND DELIVERY, thanks to digital processes, constant stock level and automated warehouses.



KONECRANES

WICK
EL. P. 000
EL. P. 000
EL. P. 000
EL. P. 000

WICK
EL. P. 000
EL. P. 000
EL. P. 000
EL. P. 000

WICK
EL. P. 000
EL. P. 000
EL. P. 000
EL. P. 000

LA STORIA

1929

Antonio Bertoli fonda Abert e dà inizio alla produzione artigianale di posate in ottone a Lumezzane (Brescia)

1960

Iniziano gli attuali processi industriali, insieme all'automatizzazione produttiva.

1975

Abert è la prima azienda al mondo a ingegnerizzare i processi per la produzione di posate colorate, con la combinazione di acciaio inossidabile e materiali come ABS, nylon e legno.

1987

La sede si trasferisce a Passirano (Brescia).

1992

Viene acquisita Facix Srl.

1993

Abert acquisisce Broggi, storico marchio milanese leader di mercato nella posateria e nei complementi d'arredo per la tavola nel settore alberghiero.

1994

Abert è la prima azienda del settore ad ottenere la certificazione di qualità ISO 9002.

2000 - 2002

La struttura logistica e produttiva dell'azienda è completamente riorganizzata con la costruzione di una sola area produttiva (10.000 mq) e una sola area logistica (20.000 mq), incrementando la sua efficienza e migliorando la flessibilità, il servizio e l'attenzione al cliente.

2002

Viene fondata PROMAB, per incontrare le esigenze di incrementare l'offerta di prodotti per la cucina in plastica e in metallo.

2007

Integrazione nel polo industriale delle lavorazioni di pulitura.

2015

Abert diventa distributore esclusivo del marchio VISTA ALEGRE, che offre prodotti per la tavola unici e differenziati, con un ottimo rapporto qualità/prezzo.

2016

Viene acquisito il marchio Inoxbeck-Becchetti (azienda leader per i complementi della tavola).

2019

L'azienda compie 90 anni di attività, guidata dalla TERZA generazione della famiglia Bertoli, durante i quali ha consolidato il rapporto con i clienti storici, conquistato nuovi mercati, sviluppato prodotti innovativi utilizzando tecnologie all'avanguardia, sempre con la storica attenzione, cura e passione.

UN'ANIMA CHE RIMANE GIOVANE,
FORTE DI UNA TRADIZIONE PIENA DI VALORI.

MILESTONES

1929

Antonio Bertoli founded Abert and started handicraft production of brass cutlery in Lumezzane (Brescia).

1960

Processing industrialization was started, together with productive automatization.

1975

Abert was the first company in the world to mechanize the production of coloured handle cutlery, matching steel with new materials, such as ABS, nylon and wood.

1987

The new factory in Passirano (Brescia) was inaugurated.

1992

Facix Srl was acquired.

1993

Abert acquired "Broggi", a prestigious company producing high level cutlery and table accessories.

1994

Abert was the first company in its field to get the Certified Management System ISO9002.

2000 - 2002

The logistic and productive structure of the company was completely reorganized with the building of a single production area (10.000 sm) with a single logistic pole (20.000 sm), increasing its efficiency and improving the flexibility, the service and the customer oriented attitude.

2002

PROMAB was established, in order to meet the need of enlarging the offer of kitchen plasticware and metalware.

2007

The production site was extended with Metalpul, the facility dedicated to polishing, in order to increase the efficiency further.

2015

Abert became exclusive distributor of Vista Alegre porcelain products, which offers a wide range of unique table items, with a good quality-price ratio.

2016

Inoxbeck-Becchetti was acquired (Holloware leader industrial company).

TODAY

Almost ninety years after its birth, still leaded by the Bertoli family on its third generation, Abert goes on aiming at innovation, product quality, sensitivity, listening to customers, based on the capability of changing with the market.

POSATE / FLATWARE	11
MODERN	17
CLASSIC	66
BASIC	85
FINITURE / FINISHING	103
ACCESSORI / ACCESSORIES	127
YUMMY	129
TUBE	133
TABLE	134
BREAK&FAST	136
COFFEE&DRINKS	138
TAPAS&APPETIZER	142
PIZZA&STEAKS	146
MARISCOS&ESCARGOTS	153
CHEESE	154
SERVING	156
INSPIRATION	173
LIGHTING	189
TAVOLA / HOLLOWWARE	209
ART&TABLE	211
MENAGE	246
LOUNGE&SERVICE	252
WINE&BAR	257
PASTICCERIA / PASTRY	283
BUFFET	307
COSMO	308
DOMINO	328
LIFE	358
URBAN	370
MIX & PLAY	384
SQUARE	392
JAMBEE	406
IMPERIAL	410
ACCESSORI BUFFET	426
CARRELLI / TROLLEY	429
CUCINA / KITCHEN	463

Alaska	80	Firenze	86	Oslo	91
Alaska Inox	80	Flair	51	Perla	74
Allegra	39	Garda Top	71	Rada	70
Amarcord	24	Gourmet	42	Relais	28
America	99	Imperial	73	Rinascimento	66
Azzurra	60	Infinito	47	Scozia	84
Baguette	76	Infinito Copper	48	Slim	31
Baguette Forte	68	Infinito Vintage	49	Splendido	72
Bivalva Roberta	100	Infinito/E	94	Step	43
Bivalva Svezia	101	Luisa	92	Stilo	33
Blade Inox	95	Luna	23	Stilo Black	34
Boston	85	Mare	59	Style	41
Brigitte	57	Marea	44	Superior	35
Clever	38	Marea Polvere di Luna	45	Supra	93
Corsaro	97	Matisse	52	Tattoo	62
Cosmos	56	Matisse Vintage	53	Tattoo Copper	64
Dinamica	40	Matisse Vintage Gold	54	Tattoo Gold	65
Dream	26	Matisse Vintage Copper	55	Toronto Inox	87
Drop	17	Med	61	Valencia	89
Duna	19	Milord	25	Valencia Inox	89
Ego	30	Mirage	46	Verve	83
Elegant	27	Monaco	50	Victory	78
England	81	Murano	90	Vintage	75
Enrico VIII	79	Murano Inox	90	Wave/A Inox	96
Ergo	29	Naif	58		
Euro	88	Neo	36		
Eva	98	Niagara	20		

PRO
SSA
TE

POSATE

Ciclo di produzione

Il ciclo di produzione di forchette e cucchiai inizia con l'operazione di tranciatura (1). Per diminuire lo spessore della tazza rispetto al manico, si procede poi con la laminazione (2), e si prosegue con la rifilatura (3), per dare la forma della tazza o dei rebbi alla posata laminata. Infine si passa alla coniazione (4), nel corso della quale vengono dati la forma e i decori necessari. Per la lavorazione dei coltelli monoblocco forgiati si parte con la tranciatura del tondino in uno spezzone (1), che viene successivamente coniato a caldo (2), in modo da conferirgli una prima forma. Si prosegue con la tranciatura del manico (3) e con l'allungamento della lama (4); in seguito viene effettuata la tranciatura della lama (5), in modo da darle la forma reale. A questo punto rimane da definire la seghettatura sulla lama (6) e rifinire il coltello con le normali operazioni di pulitura. Le fasi di lavorazione dei coltelli a manico cavo forgiati parte con la tranciatura delle valve (1). Le due valve che costituiranno il manico cavo vengono coniate a freddo (2), per dare loro la convessità e i decori, e poi vengono accoppiate e saldate (3): ecco il manico del coltello infine, attraverso un composto autobloccante, viene assemblata e saldata al manico la lama (4), prodotta con le stesse tecniche dei coltelli monoblocco forgiati.

Cutlery manufacturing process

Shearing (1) is the first step in the process of manufacturing forks and spoons. Rolling (2) is used to reduce the bowl thickness compared to that of the handle, and the next step is trimming (3) to give the shape of a bowl or prongs to the laminated implement. The final step is coining (4) during which the implement is shaped and ornamentation stamped. To make forged solid-handle knives the process begins by shearing a bar into a blank (1) that is then hot coined (2) so as to give it some initial shape. Afterwards the handle is sheared (3) and the blade is stretched (4). Then, the blade is sheared (5) so that it takes its final shape. Now blade serration (6) needs to be defined and the knife has to be polished as usual. The first step to make forged hollow-handle knives is shearing the shells (1). The two half-shells that will form the hollow handle are cold-coined (2) to obtain the convexity and stamp the decoration; afterwards the shells are coupled and welded (3). And that is how the knife handle is ready. Finally and by using a self-locking compound the blade, made applying the same techniques used to make forged solid-handle knives, is coupled and welded to the handle (4).

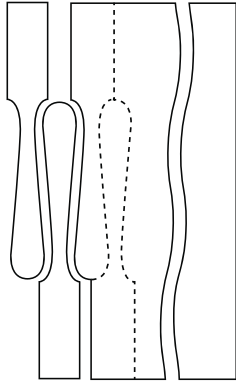

① **Tranciatura**
Blank cutting

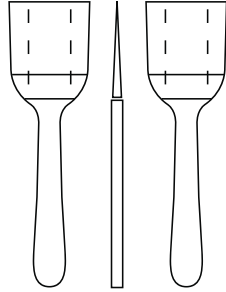

② **Laminazione**
Rolling operation

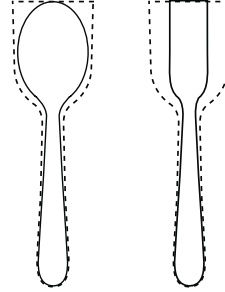

③ **Rifilatura**
Overall cutting on outside blank

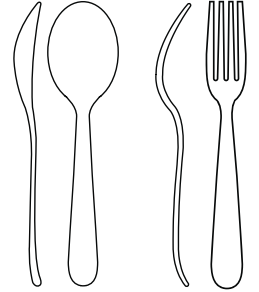

④ **Coniatura**
Pressing operation

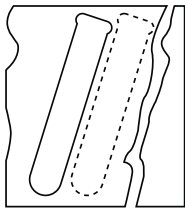

⑤ **Tranciatura**
Blank cutting



⑥ **Coniatura manico**
Handle pressing



⑦ **Saldatura gocce**
Soldering of shells

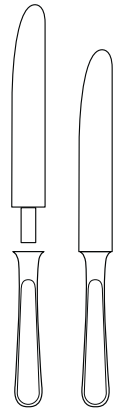

⑧ **Assemblaggio e saldatura lama manico cavo**
Assembling and soldering hollow handle knife



⑨ **Tranciatura spezzone**
Rod cutting

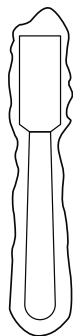

⑩ **Coniatura a caldo**
Forging

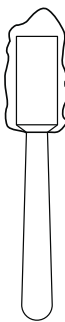

⑪ **Tranciatura manico**
Blank cutting of the blade

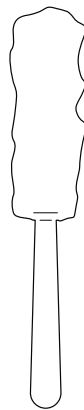

⑫ **Laminazione**
Rolling of the blade

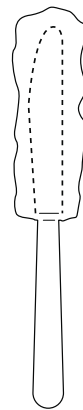



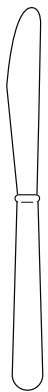







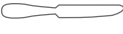



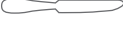

























⑬ **Ritanciatura lama**
2nd blank cutting of the blade

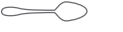

⑭ **Seghettatura e finitura**
Blade grinding and finishing

14 • Tabella posate

01		Cucchiaino tavola Table spoon Cuillère de table Eßlöffel Cuchara mesa
02		Forchetta tavola Table fork Fourchette de table Eßgabel Tenedor mesa
03		Cucchiaino brodo Bouillon spoon Cuillère à soupe Suppenlöffel Cuchara sopa
04		Coltello tavola forgiato pesante Table knife heavy-forged Couteau de table forgé lourd Tafelmesser-schwer Cuchillo mesa forjado pesado *
05		Coltello tavola forgiato Table knife-forged Couteau de table forgé Tafelmesser Cuchillo mesa forjado *
05R		Coltello tavola Reverse Reverse table knife-forged Couteau de table Reverse Tafelmesser Reverse Cuchillo mesa Reverse forjado *
06		Coltello tavola leggero Table knife-light Couteau de table léger Tafelmesser-leicht Cuchillo mesa ligero *
08		Coltello tavola m/v saldato Table knife - welded hollow-handle Couteau de table poignée creuse soudée Tafelmesser mit Hohlheft Cuchillo mesa mango hueco soldado *
11		Cucchiaino frutta Dessert spoon Cuillère à dessert Dessertlöffel Cuchara postre
12		Forchetta frutta Dessert fork Fourchette à dessert Dessertgabel Tenedor postre
14		Coltello frutta forgiato pesante Dessert knife-heavy forged Couteau à dessert forgé lourd Dessertmesser-schwer Cuchillo postre forjado pesado *
15		Coltello frutta forgiato Dessert knife-forged Couteau à dessert forgé Dessertmesser Cuchillo postre forjado *
15R		Coltello frutta Reverse forgiato Dessert knife forged-Reverse Couteau à dessert Reverse forgé Dessertmesser Reverse Cuchillo postre Reverse forjado *
16		Coltello frutta leggero Dessert knife-light Couteau à dessert léger Dessertmesser-leicht Cuchillo postre ligero *
18		Coltello frutta m/v saldato Dessert knife-welded hollow-handle Couteau à dessert poignée creuse soudée Dessertmesser mit Hohlheft Cuchillo postre mango hueco soldado *
21		Cucchiaino caffè Tea spoon Cuillère à café Kaffeelöffel Cuchara café
22		Cucchiaino moka Moka spoon Cuillère à moka Mokkalöffel Cuchara moka
23		Cucchiaino zucchero Sugar spoon Cuillère à sucre Zuckerlöffel Cuchara azucar
25		Mestolo servire Soup ladle Louche Rührlöffel Cazo sopa
26		Forchettone servire Serving fork Fourchette à servir Vortegabel Tenedor servir
27		Cucchiaino servire Serving spoon Cuillère à servir Vorlegelöffel Cucharón servir
28		Cucchiaino insalata Salad serving spoon Cuillère à servir salade Salatlöffel Cucharón servir ensalada
29		Forchettone insalata Salad serving fork Fourchette à servir salade Salatgabel Tenedor servir ensalada
30		Cucchiaino riso Rice-serving spoon Cuillère à riz Reislöffel Cucharón arroz
31		Forchetta pesce Fish fork Fourchette à poisson Fischgabel Tenedor pescado
32		Coltello pesce Fish knife Couteau à poisson Fischmesser Cuchillo pescado
33		Forchettone servire pesce Fish serving fork Fourchette à servir poisson Servierfischgabel Tenedor servir pescado
34		Coltello servire pesce Fish serving knife Couteau à servir poisson Servierfischmesser Cuchillo servir pescado
35		Cucchiaino bibita Ice tea spoon Cuillère à cocktail Cocktaillöffel Cuchara refresco
37		Paletta gelato Ice cream spoon Cuillère à glace Speiseeislöffel Cuchara helado
38		Forchettina dolce Cake fork Fourchette à tarte Kuchengabel Tenedor lunch
39		Pala dolce Cake server Pelle à tarte Tortenschaufel Pala pastel
40		Coltellone dolce Cake knife Gros couteau à tarte Tortenmesser Cuchillo pastel
42		Mestolino salsa Sauce ladle Louche à sauce Soßeschöpfel Cacillo salsa
43		Spalmaburro Butter spreader Couteau à beurre Buttermesser Pala mantequilla
45		Spalmaburro Butter spreader Couteau à beurre Buttermesser Pala mantequilla
53		Spalmaburro forgiato Butter spreader - forged Couteau à beurre forgé Buttermesser Pala mantequilla forjado *
55		Coltello bistecca Steak knife Couteau à bifteck Filetmesser Cuchillo carne *
63		Forchetta lumache 2 punte 2 prongs snail fork Forchette à escargots à deux dents Zweizinkengabel für Schnecke Tenedor caracoles dos puntas
64		Forchettina ostriche Oyster fork Forchette à crustacés Auster Krustazeengabel Tenero mariscos
67		Cucchiaino salsa Sauce spoon Cuillère à sauce Soßelöffel Cuchara salsa
80		Cucchiaino lunch Lunch spoon Cuillère à lunch Lunchlöffel Cuchara lunch

* materiale: acciaio inox | material: stainless steel |
matériel: acier Inoxydable | Material: aus Edelstahl | material: acero Inoxidable

Istruzioni d'uso e di manutenzione per la posateria e il vasellame in acciaio Inox

Lavare accuratamente i prodotti nuovi prima di utilizzarli. Utilizzare per il lavaggio acqua calda ed un buon sapone neutro, risciacquare in seguito con abbondante acqua tiepida ed asciugare scrupolosamente tutti gli articoli.

Non utilizzare per il lavaggio detersivi sintetici a base di cloro o prodotti comunque candeggianti.

Pomice, paglietta d'acciaio, spugnette o panni impregnati di polveri abrasive devono essere altresì rigorosamente esclusi. Possono invece essere utilizzati detersivi non clorurati contenente farina fossile.

E' consigliato il lavaggio degli articoli in acciaio Inox subito dopo il loro utilizzo. Qualora questo non fosse possibile è comunque importante non lasciare per più di 12 ore gli articoli sporchi a contatto con i residui alimentari (es: in caso di utilizzo degli articoli a pranzo, andrebbero lavati entro la sera del giorno stesso; in caso di utilizzo degli articoli a cena, andrebbero lavati entro la mattina del giorno seguente).

Nel caso fosse necessario un prelavaggio, questo deve essere fatto appena prima del lavaggio e per un tempo relativamente breve. Gli articoli non vanno infatti lasciati in ammollo nella soluzione lavante per troppo tempo in quanto alcune sostanze contenute negli alimenti sono dannose per l'acciaio Inox e ne alterano

l'aspetto. I coltelli e le lame dei coltelli (in caso di articolo a manico cavo) prodotte con un pregiato acciaio inox, sono sensibili agli attacchi corrosivi sviluppati dall'acido acetico, citrico, lattico ed in particolare da cloruro di sodio, presenti negli alimenti.

E' importante, sia in fase di prelavaggio che durante il lavaggio, tenere separate le normali posate (cucchiai, forchette, cucchiaini) dai coltelli e da altri oggetti metallici presenti in cucina.

Nel caso di lavaggio in lavastoviglie le posate devono essere inserite in cestelli verticali di plastica e tenute separate dai coltelli.

Asciugare accuratamente gli articoli con un panno morbido subito dopo il lavaggio, anche se il lavaggio è eseguito in lavastoviglie che prevede un ciclo di asciugatura automatica. Questo è necessario per evitare l'eventuale formazione di macchie dovute a depositi calcarei contenuti nell'acqua.

Non lasciare le posate nell'ambiente umido della lavastoviglie una volta terminato il ciclo di lavaggio, ma asciugarle e riporle in un ambiente asciutto.

Si consiglia di conservare gli articoli perfettamente asciutti, in un ambiente privo di umidità.

Per evitare rigature si consiglia di non conservare alla rinfusa gli articoli ma di riporli ordinatamente e proteggerli con un panno morbido.

Instructions for use and maintenance of stainless steel cutlery and hollowware

Wash the new products carefully before use.

Use hot water to wash them and a good neutral detergent; then, rinse out with lukewarm water and dry all the items thoroughly.

When washing, do not use chlorinated detergents nor products containing bleach.

Pumice, steel wool, sponges or cloths saturated with abrasive powders must be strictly avoided. However, detergents without chloride containing fossil flour can be used.

The washing of stainless steel items after use is recommended. In case that would not be possible, it is however important not to leave for more than 12 hours the dirty items in contact with food leftovers (e.g.: if the items are used at lunch, they should be washed within the evening; if the items are used at dinner, they should be washed within the following morning).

In case a prewash was needed, it must be carried out just before the washing and for a relatively short time. In fact, the items must not be soaked in the washing solution for too long, since some substances contained in food are damaging for the stainless steel and change its appearance. Knives and knife blades (for hollow

handle items) are manufactured with a valuable stainless steel and are sensitive to the corrosion attacks developed by acetic, citric and lactic acid and in particular to sodium chloride present in food.

It is important, both when pre-washing and washing, to keep cutlery like spoons, forks and tea spoons, separated from knives and other metal kitchenware.

In case of washing in dishwasher, spoons and forks must be placed into plastic vertical baskets and kept separated from knives.

Dry the items thoroughly immediately after the washing with a soft cloth, even if your dishwasher has a dry cycle.

That is necessary in order to avoid the possible formation of stains caused by calcareous deposits contained in the water.

Do not leave the cutlery in the humid environment of the dishwasher once the washing finishes; dry them and store them in a dry place.

It is recommended to store the items perfectly dried and in a location without humidity.













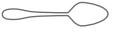

In order to avoid scratches, it is recommended not to keep the items randomly, but if it is possible, to protect them by soft cloth.





Drop

Inox 18/10 - St. Steel - 4 mm
Cod. CBD..











COD. CBD..		L. mm
01		209
02		208
03		176
05		235
11		188
12		188
15		212
21		146
22		115
26		240
27		240
31		188
32		203
38		146
53		165





Duna

Inox 18/10 - St. Steel - 3 mm
Cod. CBL..

COD. CBL..		L. mm
01		206
02		205
03		180
05		230
11		185
12		184
21		123
22		109
31		154
32		184
38		200











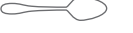

Niagara

Inox 18/10 - St. Steel - 5 mm
Cod. CZ3..



COD. CZ3..

L. mm

01		210
02		210
05		231
11		181
12		183
15		210
21		147
22		113
25		306
26		237
27		234
38		160
39		250
53		175
55		228











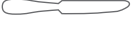

Luna

Inox 18/10 - St. Steel - 5 mm
Cod. CHP..



COD. CHP..		L. mm
01		200
02		202
05		225
11		193
12		193
15		212
21		140
22		106
38		142

Amarcord

Inox 18/10 - St. Steel - 5mm
Cod. CC2..



COD. CC2..

L. mm

01  214

02  216

03  193

05  235

11  193

12  193

15  212

21  150

22  113

25  305

26  247

27  247

31  185

32  206

38  148

39  251

53  176

55  230



Milord

Inox 18/10 - St. Steel - 4 mm

Cod. C14..

COD. C14..		L. mm
01		200
02		200
03		172
05		230
08		225
11		177
12		178
15		195
18		200
21		133
22		104
25		310
26		228
27		227
28		227
29		225
30		250
31		198
32		212
35		195
36		172
37		129
38		143
39		240
42		175
53		168
55		230
67		184















Dream

Inox 18/10 - St. Steel - Forg.
Cod. CF9..



COD. CF9..



















L. mm

01		208
02		208
05		235
11		187
12		187
15		210
21		145
22		115
26		239
27		239
30		254
32		198
38		145
39		248



Elegant

Inox 18/10 - St. Steel - 3,5 mm
Cod. CV6..

COD. CV6..		L. mm
01		208
02		208
03		185
05		240
05R		236
11		185
12		185
15		210
15R		204
21		142
22		114
25		314
26		231
27		229
31		182
32		197
38		145
39		240
53		175













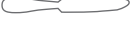



Relais

Inox 18/10 - St. Steel - 4 mm
Cod. CU3..



COD. CU3..













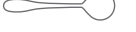



L. mm

01		210
02		210
03		185
05		235
11		187
12		192
15		212
21		135
22		112
25		305
26		240
27		240
31		185
32		197
38		143
39		247
53		176
55		230



Ergo

Inox 18/10 - St. Steel - 4 mm
Cod. CE5..

COD. CE5..		L. mm
01		207
02		207
03		182
05		231
11		186
12		186
15		209
21		145
22		114
25		306
26		237
27		234
32		215
38		150
39		250
53		175
55		228

Ego

Inox 18/10 - St. Steel - 4 mm
Cod. CD3..



COD. CD3..

L. mm



207



207



182



231



186



186



209

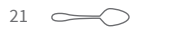

145



114



306



237



234



278



215



150











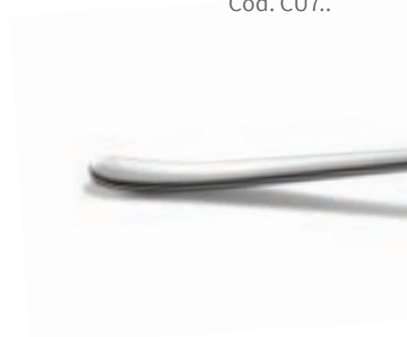





250



Slim

Inox 18/10 - St. Steel - 4 mm
Cod. CU7..



COD. CU7..		L. mm
01		202
02		202
03		193
05		235
11		193
12		193
15		212
21		150
22		113
32		214
38		148
53		176
55		230





Stilo

Inox 18/10 - St. Steel - 3 mm
Cod. CST..



COD. CST..		L. mm
01		200
02		200
03		180
05		230
11		180
12		180
15		206
21		141
22		110
25		295
26		238
27		238
28		223
29		221
30		260
32		194
38		148
39		242
53		165

Stilo

Black

Inox 18/10 - St. Steel - 3 mm
Cod. CST42..



COD. CST42..

L. mm



200



200



230



141















110



Superior

Inox 18/10 - St. Steel - 3 mm
Cod. CZ4..



COD. CZ4..		L. mm
01		205
02		206
03		175
05		235
11		185
12		186
15		210
21		137
22		107
31		180
32		200
38		143

Neo

Inox 18/10 - St. Steel - 3 mm
Cod. CHU..



COD. CHU..

L. mm

01  210

02  210

03  180

05  232

11  190

12  190

15  207

21  148

22  114

25  305

26  239

27  239

32  215

38  147

39  251

53  175

55  219



Clever

Inox 18/10 - St. Steel - 4 mm
Cod. CHG..



COD. CHG..

L. mm



200



202



225



193



193



212



140



106













142



Allegra

Inox 18/10 - St. Steel- 3 mm
Cod. CM6..

COD. CM6..		L. mm
01		226
02		226
05		235
11		180
12		180
15		203
21		140
22		106
38		155
53		176
55		230

Dinamica

Inox 18/10 - St. Steel - 3 mm
Cod. CM7..



COD. CM7..

L. mm



210



213



235



190



180



210



133

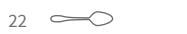

110



290



241



241



206



213



160



















241



Style

Inox 18/10 - St. Steel - 3 mm
Cod. CD6..

COD. CD6..		L. mm
01		202
02		202
03		180
05		230
11		182
12		182
15		208
21		140
22		108
25		310
26		232
27		233
32		201
35		195
38		146
39		246

Gourmet

Inox 18/10 - St. Steel - 3 mm
Cod. CF5..



COD. CF5..

L. mm



197



197



172



227



195



177



202



131



103



153













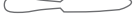





219



Step

Inox 18/10 - St. Steel - 3 mm
Cod. CF8..

COD. CF8..		L. mm
01		200
02		202
03		178
05		226
11		179
12		181
15		207
21		140
22		109,7
25		290
26		231
27		234
30		260
31		180
32		193
38		146
39		255
53		170

Marea

Inox 18/10 - St. Steel - 3 mm
Cod. CE4..



COD. CE4..	L. mm
01	200
02	200
03	169
05	235
11	173
12	175
15	210
21	134
22	117
25	285
26	232
27	230
28	230
29	225
30	260
32	202
35	210
38	155
39	249
42	150
53	175







Marea

Polvere di Luna - Moondust

Inox 18/10 - St. Steel - 3 mm
Cod. CE432 ..

COD. CE432..

L. mm

01		200
02		200
05		235
21		134
22		117



















Mirage

Inox 18/10 - St. Steel - 2,5 mm
Cod. C17..



COD. C17..











L. mm

01		200
02		200
03		170
05		223
06		223
11		178
12		179
15		199
21		135
22		110
25		314
26		230
27		229
31		203
32		222
35		210
38		159
39		247
55		210



Infinito

Inox 18/10 - St. Steel- 2,5 mm
Cod. CV7..

COD. CV7..		L. mm
01		205
02		205
03		182
05		231
11		186
12		186
15		209
21		145
22		114
38		150

Infinito

Copper

Inox 18/10 - St. Steel- 2,5 mm
Cod. CV740..



COD. CV740..

L. mm



205



205



231



145











114



Infinito

Vintage

Inox 18/10 - St. Steel- 2,5 mm
Cod. CV751..

	COD. CV751..	L. mm
01		205
02		205
03		182
05		231
11		186
12		186
15		209
21		145
22		114
38		150













Monaco

Inox 18/10 - St. Steel - 2,5 mm
Cod. C34..



COD. C34..











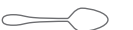

L. mm

01		196
02		195
05		218
11		170
12		173
15		190
21		131
22		110
27		223
32		205
38		155
39		238
42		158



Flair

Inox 18/10 - St. Steel - 2,5 mm
Cod. C02..

COD. C02..		L. mm
01		202
02		202
05		222
11		178
12		179
15		199
21		135
22		110
31		203
32		222
38		159
39		247
53		175
55		220

Matisse

Inox 18/10 - St. Steel - 2,5 mm
Cod. CF1..

COD. CF1..	L. mm
01	204
02	205
03	168
05	238
11	178
12	178
15	208
21	137
22	110
25	295
26	240
27	237
31	203
32	210
35	207
37	133
38	153
39	238
42	170
53	178
55	230
63	156
64	156
80	158



























Matisse

Vintage

Inox 18/10 - St. Steel - 2,5 mm
Cod. CF151..

COD. CF151..		L. mm
01		204
02		205
03		168
05		230
11		178
12		178
15		208
21		137
22		110
25		295
26		240
27		237
31		203
32		210
35		207
37		133
38		153
39		238
53		178
55		230
63		156
64		156
80		158

Matisse

Vintage Gold

Inox 18/10 - St. Steel - 2,5 mm
Cod. CF157..



COD. CF157..

L. mm



204



205



230



137







110



Matisse

Vintage Copper

Inox 18/10 - St. Steel - 2,5 mm
Cod. CF156..









COD. CF156..		L. mm
01		204
02		205
05		230
21		137
22		110

Cosmos

Inox 18/10 - St. Steel - 2,5 mm
Cod. C06..



COD. C06..















- 01  197
- 02  199
- 05  213
- 11  177
- 12  179
- 15  200
- 21  130
- 22  108
- 38  150

L. mm



Brigitte

Inox 18/10 - St. Steel - 2 mm
Cod. C68..

COD. C68..	L. mm
01 	195
02 	197
06 	213
21 	131
22 	103
25 	315
26 	230
27 	226
31 	190
32 	210
35 	207
38 	153
39 	240
42 	170

Naif

Inox 18/10 - St. Steel - 1,8 mm
Cod. CE8..



COD. CE8..

L. mm



200



202



222



136











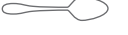

155

Mare

Acciaio Inox - St. Steel - 3 mm
Cod. CN8..



COD. CN8..		L. mm
01		202
02		202
05		222
11		173
12		175
15		191
21		134
22		117
38		155
53		175
80		144











Azzurra

Acciaio Inox - St. Steel - 2,2mm
Cod. CZ7..



COD. CZ7..





L. mm

01		202
02		202
05		222
11		173
12		175
15		191
21		134
22		117
38		155
55		225
134		144



Med

Acciaio Inox - St. Steel - 2,2 mm
Cod. CT1..

COD. CT1..		L. mm
01		204
02		205
05		230
21		137
22		110

Tattoo

Inox 18/10 - St. Steel- 2 mm
Cod. CD5TA..



COD. CD5TA..

L. mm



198



200



230



132



154



Tattoo

Copper

Inox 18/10 - St. Steel- 2 mm
Cod. CD5TA40..



COD. CD5TA40..

L. mm



198



200



230



132







154

Tattoo

Gold

Inox 18/10 - St. Steel- 2 mm
Cod. CD5TA41..



COD. CD5TA41..		L. mm
01		198
02		200
05		230
21		132
38		154

Rinascimento

Inox 18/10 - St. Steel - 3 mm
Cod. CHA..













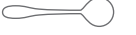
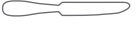

COD. CHA..	L. mm
01	198
02	200
03	170
05	235
11	176
12	179
15	210
21	133
22	107
25	315
26	239
27	239
31	186
32	210
38	154
39	240
53	170

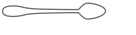

Baguette Forte

Inox 18/10 - St. Steel - 3mm
Cod. CHV..



























COD. CHV..		L. mm
01		204
02		208
03		172
05		235
11		184
12		185
15		211
21		138
22		110
31		185
32		193
35		207
38		144
53		170



Rada

Inox 18/10 - St. Steel - 3 mm
Cod. C29..

COD. C29..	L. mm
01 	208
02 	206
03 	175
04 	236
05 	230
08 	235
11 	187
12 	187
14 	216
15 	210
18 	215
21 	142
22 	141
25 	300
26 	227
27 	225
31 	182
32 	201
35 	139
37 	152
38 	142
39 	240
42 	160
53 	174
55 	220















Garda Top

Inox 18/10 - St. Steel - 4 mm
Cod. C82T..

COD. C82T..

L. mm

01		210
02		210
05		235
11		184
12		184
15		212
21		140
22		110
32		220
38		150

Splendido

Inox 18/10 - St. Steel - 3,5 mm
Cod. C19..



COD. C19..

L. mm

01  201

02  200

03  178

05  237

11  180

12  180

15  201

21  140

22  106

25  303

26  230

27  229

31  200

32  214

38  148

39  242

43  170

Imperial

Inox 18/10 - St. Steel - 3 mm
Cod. C04..













COD. C04..		L. mm
01		207
02		208
03		174
05		246
08		247
11		187
12		188
15		216
18		214
21		141
22		111
23		116
25		315
26		239
27		239
28		206
29		205
31		186
32		210
33		242
34		260
35		192
36		174
37		133
38		145
39		240
40		255
42		164
53		170
55		220

Perla

Inox 18/10 - St. Steel - 3 mm
Cod. CZ1..



















COD. CZ1..	L. mm
01 	200
02 	201
03 	176
05 	228
11 	180
12 	180
15 	204
21 	140
22 	104
31 	197
32 	208
38 	152



Vintage

Inox 18/10 - St. Steel - 3 mm
Cod. CB5..

COD. CB5..		L. mm
01		205
02		206
05		230
11		187
12		187
15		206
21		142
22		117
25		300
26		227
27		225
31		181
32		202
38		152
39		242
40		237
55		203

Baguette

Inox 18/10 - St. Steel - 2,5 mm
Cod. CP1..

COD. CP1..

L. mm



205



205



169



250



225



179



179



195



200

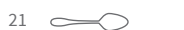

143

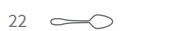

110



295



239



236



205



211



207

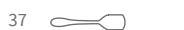

133



154



238



178



175



212



179





Victory

Inox 18/10 - St. Steel - 2,5 mm
Cod. CP2..

COD. CP2..



205



205



167



230



178



179



208



137

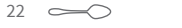

110



299



239



236



203



210



206



132



153



235



170



176



170



227















160















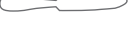

Enrico VIII

Inox 18/10 - St. Steel - 2,5 mm
Cod. CUB..

COD. CUB..		L. mm
01		203
02		204
03		168
05		235
11		186
12		184
15		200
21		137
22		121
31		182
32		193
38		142









Alaska

Inox 18/10 - St. Steel - 2,5 mm
Cod. C24..

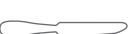
COD. C24..		L. mm
01		195
02		195
05		212
06		212
11		175
12		176
15		190
21		137
22		103
38		152
39		224
40		223
42		175

Alaska Inox

Inox 18/CR - St. Steel - 1,8 mm
Cod. CG3..

COD. CG3..		L. mm
01		195
02		195
06		212 *
21		128
22		117
35		208
37		134
38		175











*C2406





England

Inox 18/10 - St. Steel - 2,2 mm
Cod. C97RO..

COD. C97RO..	L. mm
01 	203
02 	201
05 	218
11 	180
12 	180
15 	203
21 	140
22 	106
35 	192
38 	144
39 	245







England

Inox 18/CR - St. Steel - 2,2 mm
Cod. CH9...



Cod. CH9...









L. mm

- 01  203
- 02  201
- 05  218
- 11  180
- 12  180
- 15  203
- 21  140



Verve

Inox 18/10 - St. Steel - 1,8 mm
Cod. C37..









COD. C37..		L. mm
01		200
02		204
03		166
05		230
06		232
21		140
22		105
38		145

Scozia

Inox 18/CR - St. Steel - 3,0 mm
Cod. CN6..



COD. CN6..

- 01  200
- 02  200
- 05  222
- 11  180
- 12  180
- 15  203
- 21  138
- 22  105
- 38  143













L. mm

- 200
- 200
- 222
- 180
- 180
- 203
- 138
- 105
- 143



Boston

Inox 18/10 - St. Steel - 2,5 mm
 Manico satinato - Mat finishing handle
 Cod. C39..

COD. C39..		L. mm
01		195
02		196
05		210
11		173
12		177
15		192
21		132
22		116
31		190
32		204
35		206
37		131
38		153

Firenze

Inox 18/10 - St. Steel - 2,5 mm
Cod. C84..



COD. C84..



195



196



210



173



175



194

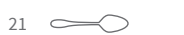

132

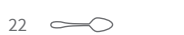

116











152

L. mm



Toronto Inox

Inox 18/CR - St. Steel - 1,8 mm
Cod. CG8..

COD. CG8..		L. mm
01		195
02		196
* 05		209
21		132
22		116
35		206
37		131
38		153

*CH805

Euro

Inox 18/10 - St. Steel - 2 mm
Cod. CR3MH..



COD. CR3MH..

L. mm



197



193



222



222



131



116



154

Valencia

Inox 18/10 - St. Steel - 1,8 mm
Cod. CR9..



COD. CR9..		L. mm
01		195
02		198
03		169
05		215
06		215
11		177
12		179
15		209
16		192
21		138
22		110
25		298
26		240
27		236
31		198
32		201
35		207
38		154

Valencia Inox







Inox 18/CR - St. Steel - 1,8 mm
Cod. CG2..

COD. CG2..		L. mm
01		195
02		198
* 06		215
11		177
12		179
* 16		192
21		138
22		110
35		207
37		135
38		154
80		215

*CR9..

Murano







Inox 18/10 - St. Steel - 1,8 mm
Cod. CD5..

COD. CD5..	L. mm
01 	199
02 	201
06 	213
21 	140
22 	105
38 	145



Murano Inox

Inox 18/CR - St. Steel- 1,8 mm
Cod. CG5..

COD. CG5..	L. mm
01 	199
02 	201
* 06 	211
21 	140
22 	105
35 	187
38 	145

*CD506









Oslo

Inox 18/CR - St. Steel - 2 mm
 Manico satinato - Mat finishing handle
 cod. C49..



COD. C49..

L. mm

01		194
02		192
05		210
11		174
12		177
15		190
21		127
22		113
38		151











Luisa

Inox 18/10 - St. Steel - 1,8 mm
Cod. CS4..



COD. CS4..

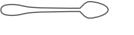





L. mm

- 01  193
- 02  196
- 06  222
- 11  179
- 12  180
- 16  190
- 21  130
- 22  124
- 35  187
- 38  145



Supra

Acciaio Inox - St. Steel - 1,8mm
Cod. CBA..

COD. CBA..		L. mm
01		202
02		202
05		222
21		134
22		117
38		155

Infinito/e

Inox 18/CR - St. Steel- 1,8 mm
Cod. CHS..



COD. CHS..

L. mm



205



205



231



145



114









150



Blade Inox

Inox 18/CR - St. Steel - 1,8 mm
Cod. CHL..

COD. CHL..		L. mm
01		200
02		200
06		220
21		141
22		105
38		141







Wave/A Inox

Inox 18/CR - St. Steel - 1,8 mm
Cod. CHD..



COD. CHD..







L. mm

- 01  200
- 02  202
- 06  220
- 21  140
- 22  106
- 35  207
- 38  142



Corsaro

Inox 18/CR - St. Steel - 1,5 mm
Cod. CV1..

COD. CV1..		L. mm
01		195
02		195
05		210
21		130
22		103
38		159









Eva

Inox 18/CR - St. Steel - 1,5 mm
Cod. CT4E..



COD. CT4E..

L. mm

01	
02	
06	
21	
22	
35	
37	
38	

194

193

213

129

110

207

134

154









America

Inox 18/CR - St. Steel - 1,5 mm
Cod. C46..

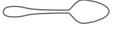
COD. C46..

L. mm

01		193
02		193
06		212
11		173
12		170
21		120
22		102
38		141

Bivalva Roberta

Roberta blister
Blister Roberta
Sichtbare Blase
Blister Roberta

Acciaio Inox 18/CR - St. Steel **L.mm**

Cucchiaino tavola	F85 22 401 pcs 24	190
Forchetta tavola	F85 22 402 pcs 24	190
Coltello tavola	F85 21 205 pcs 12	213
Cucchiaino caffè	F85 24 821 pcs 48	120
Forchetta dolce	F85 23 638 pcs 36	150



Bivalva Svezia

Svezia blister
Blister Svezia
Sichtbare Blase
Blister Svezia

Acciaio Inox 18/CR - St. Steel

			L.mm
Cucchiaino bibita	FSV21835	pcs 18	204
Palette gelato	FSV21837	pcs 18	131
Forchettina dolce	FSV22438	pcs 24	145
Cucchiaino caffè	FSV23021	pcs 30	140
Cucchiaino moka	FSV23622	pcs 36	105



PRO
SATA
TTE
RIA

FINITURE SPECIALI

Finiture di tendenza e nuances raffinate che suscitano nuove sensazioni, trasmettono stile e personalizzano la mise en place.

Trendy finishes and refined nuances that arouse new sensations, convey style and personalise the mise-en-place.

Finitions de tendance et nuances raffinées qui donnent des sensations nouvelles, en transmettant style et en personnalisant la mise en place des tables.

Acabados de tendencia y tonos refinados que provocan nuevas sensaciones, transmiten estilo y personalizan la mise en place.

Trendige Oberflächen und raffinierte Nuancen, die neue Empfindungen wecken, Stil vermitteln und das Mise en Place personalisieren.

FINITURE SPECIALI - SPECIAL FINISH

Vintage

L'opacità, i graffi ed i segni volutamente prodotti sulla superficie delle posate con finitura Vintage danno la sensazione di oggetti vissuti ed utilizzati a lungo, di grandi cucine profumate, calde e piene di vapore, di convivialità di altri tempi, di sapori antichi. Evocano immagini di ambienti tradizionali, rustici e senza pretese di modernità.

Opacity, scratches and marks intentionally made on the surface of the cutlery with a Vintage finish give the effect of objects that have been used for a long time, of a large, warm and steamy kitchen filled with aromas, of the friendly gatherings of old good times and ancient flavours. They evoke images of traditional, simple environments with no intention to be modern.

L'opacité, les égratignures et les marques intentionnellement produites sur la surface des couverts à finition Vintage donnent le sentiment d'objets vécus et utilisés depuis longtemps, de grandes cuisines odorantes, chaudes et pleines de vapeur, de convivialité d'autrefois, de saveurs d'antan. Elles évoquent des images de lieux traditionnels, rustiques et sans prétention de modernité.

La opacidad, los rasguños y las marcas producidos deliberadamente en la superficie de los cubiertos con acabado Vintage dan la sensación de objetos vívidos y utilizados por largo tiempo, de grandes cocinas perfumadas, cálidas y llenas de vapor, de convivialidad de otros tiempos, de sabores antiguos. Evocando imágenes de ambientes tradicionales, rústicos y sin pretensiones de modernidad.

Der Mattglanz, die "Kratzer" und gezielt in die Oberfläche eingearbeiteten Zeichen der Serie 'Vintage' verleihen diesem Besteck einen besonders raffinierten Look von seit langem benutzten Gegenständen, erinnern an die Atmosphäre großer gemütlicher Wohnküchen von früher, wo es herrlich nach den Gerichten unserer Kindheit duftete. Sie rufen Bilder traditioneller Ambiente wach, ohne dem Anspruch moderner Stilformen nachzugeben.

Polvere di Luna

La finitura Polvere di Luna rende l'aspetto delle posate satinato e delicatamente brillante: una superficie levigata con chiaroscuri. Piacevoli e vellutate al tatto, trasmettono una morbidezza ed un calore inconsueto per oggetti di acciaio. Un rivestimento sobrio ed inusuale per posate contemporanee.

The Polvere di Luna finish makes cutlery surface look satin-like and delicately brilliant: a smooth surface with contrasting shades. Pleasant and velvety to the touch, the cutlery so treated convey a softness and warmth unusual for steel objects. A sober and unusual coating for contemporary cutlery.

La finition Polvere di Luna rend l'aspect des couverts satiné et délicatement brillant : une surface polie avec des clairs-obscur. Agréables et veloutées au toucher, ils transmettent une douceur et une chaleur insolites pour des objets en acier. Un revêtement sobre et inusuel pour des couverts contemporains.

El acabado Polvere di Luna confiere a los cubiertos un aspecto satinado y delicadamente brillante: una superficie pulida con claroscuros. Agradables y aterciopelados al tacto, transmiten una suavidad y una calidez insólitas en objetos de acero. Un revestimiento sobrio e inusual para cubiertos contemporáneos.

Die Oberflächenbearbeitung 'Polvere di Luna' verleiht dem Besteck samt dem Glanz mit edlen hell-dunkel Schattierungen. Von ausgesprochen gepflegter Haptik, liegt dieses Besteck weich und besonders angenehm in der Hand und strahlt eine für Stahl ungewöhnliche Wärme aus. Ein dezentes und einzigartiges Oberflächenfinish für zeitgenössisches Besteck.

Scotch-Brite

Questo effetto superficiale, tipicamente utilizzato nell'architettura di interni, è caratterizzato dalla presenza di molteplici e lievissime graffiature longitudinali; dona al metallo una sembianza velata e luminosa al tempo stesso, conferendo agli oggetti che riveste un aspetto di brillantezza pacata, di acciaio non lucente. Per utensili che evocano il design di stile nordico.

This superficial effect, typically used in the interior architecture, is characterized by the presence of numerous and very light longitudinal scratches; it adds to the metal a veiled and bright appearance at the same time, bestowing to the objects it covers an aspect of measured brilliance, of non-glowing steel. For tools that evoke northern design.

Cet effet de surface, typiquement utilisé dans l'architecture d'intérieur, se caractérise par la présence de plusieurs et très légères éraflures longitudinales; cela rend le métal d'une apparence voilée et lumineuse en même temps, en donnant aux objets un aspect d'éclat paisible, d'acier pas brillant. Pour outils qui évoquent le design du style nordique.

Este efecto superficial, típicamente utilizado en la arquitectura de interiores, se caracteriza por la presencia de múltiples rasguños longitudinales; proporciona al metal una apariencia velada y luminosa al mismo tiempo, otorgando a los objetos que cubre un aspecto de brillo sosegado, de acero no reluciente. Para utensilios que evocan diseño de estilo nórdico.

Dieser Oberflächeneffekt, der typischerweise in der Innenarchitektur verwendet wird, charakterisiert sich für das Vorhandensein mehrerer und sehr geringer Längskratzer. Es verleiht dem Metall gleichzeitig einen verschleihten und leuchtenden Anschein und verleiht den Objekten, die es abdeckt, einen Aspekt ruhiger Brillanz und nicht glänzenden Stahls. Scotch-brite ist ideal für Werkzeuge, die an das nordische Design erinnern.



Polvere di Luna

Moon Dust
Cod. ...32



Finitura disponibile per tutti i modelli

Finish available for all models

Non disponibile per posate a manico cavo

Not available for hollow-handle cutlery

Minimo di ordine 500 pz assortiti

500 assorted pcs minimum order



Vintage

Vintage
Cod. ...51

Finitura disponibile per tutti i modelli

Finish available for all models

Non disponibile per posate a manico cavo

Not available for hollow-handle cutlery

Minimo di ordine 500 pz assortiti

500 assorted pcs minimum order

Scotch-Brite

Inox Scotch Brite
Cod. ...73



Finitura disponibile per tutti i modelli

Finish available for all models

Non disponibile per posate in PVD

Not available in PVD cutlery

Minimo di ordine 500 pz assortiti

500 assorted pcs minimum order

PVD

The PVD (Physical Vapour Deposition) technique allows to deposit a high-thickness metal film with remarkable characteristics from the decorative and technical point of view. Such process makes the product treated durable in time and gives high surface hardness. The item turns resistant to solvents, acids and to various products used in the kitchen, keeping its chemical/physical characteristics unchanged. It is a thoroughly biocompatible, anallergic treatment and suitable for food contact.

La technique PVD (Physical Vapour Deposition) permet de déposer un film métallique de haute épaisseur avec des caractéristiques surprenantes du point de vue décoratif et technique. Ce processus rend le produit traité durable et confère une dureté superficielle élevée. L'article devient résistant aux solvants, aux acides et aux différents produits employés en cuisine, gardant intactes ses propres caractéristiques chimio/physiques. C'est un traitement absolument biocompatible, anallergique et approprié au contact avec la nourriture.

La técnica PVD (Physical Vapour Deposition) permite depositar una película metálica de alto grosor con características sorprendentes desde el punto de vista decorativo y técnico. Este procedimiento hace que el producto tratado sea duradero en el tiempo y le

confiere una elevada dureza superficial. El artículo se torna resistente a los solventes, a los ácidos y a los diversos productos empleados en la cocina, manteniendo intactas sus características químico/físicas. Es un tratamiento absolutamente biocompatible, antialérgico y apto para el contacto con los alimentos.

Die PVD Technik ermöglicht die Beschichtung mit einem dickwandigen Metallfilm von überraschenden dekorativen und technischen Merkmalen. Das Verfahren verleiht dem Produkt längere Lebensdauer und eine ausgeprägte Oberflächenhärte, macht beständig gegen Lösungsmittel, Säuren und verschiedene Haushaltsmittel, wobei die chemischen und physischen Eigenschaften des Produkts selbst intakt bleiben. Die Behandlung ist absolut bioverträglich, allergenfrei und lebensmitteltauglich.

La tecnica PVD (Physical Vapour Deposition) permette di depositare un film metallico di alto spessore con caratteristiche sorprendenti dal punto di vista decorativo e tecnico. Questo procedimento rende il prodotto trattato durevole nel tempo e conferisce elevata durezza superficiale. L'articolo diventa resistente ai solventi, agli acidi e a vari prodotti usati in cucina, mantenendo intatte le proprie caratteristiche chimico/fisiche. E' un trattamento assolutamente biocompatibile, anallergico ed idoneo al contatto con il cibo.



PVD Oro

PVD Gold

Cod. ...41

PVD Rame

PVD Copper

Cod. ...40

PVD Nero

PVD Black

Cod. ...42

PVD Bronzo

PVD Bronze

Cod. ...85

PVD Champagne

PVD Champagne

Cod. ...80





**Polvere di Luna
PVD Oro**

Moon Dust PVD Gold

Cod. ...35



**Polvere di Luna
PVD Rame**

Moon Dust PVD Copper

Cod. ...53



**Polvere di Luna
PVD Nero**

Moon Dust PVD Black

Cod. ...39



**Polvere di Luna
PVD Bronzo**

Moon Dust PVD Bronze

Cod. ...83



**Polvere di Luna
PVD Champagne**

Moon Dust PVD
Champagne

Cod. ...78





Vintage PVD Oro
Vintage PVD Gold

Cod. ...57



Vintage PVD Rame
Vintage PVD Copper

Cod. ...56



Vintage PVD Nero
Vintage PVD Black

Cod. ...76



Vintage PVD Bronzo
Vintage PVD Bronze

Cod. ...84





WASSEL
LA
ME

FINITURE SPECIALI

The range of special finishes can be applied to hollowware products as well, creating contemporary taste combinations. Matching finishes and colours you can customise your style, enhancing it with new looks and unusual effects.

La gamme de finitions spéciales peut être appliquée aux accessoires aussi, en créant combinaisons du goût contemporain. En assortant finitions et couleurs il est possible de personnaliser son propre style, en l'enrichissant par présentations nouvelles et effets inhabituels.

La gama de acabados especiales se puede aplicar en productos de vajilla también, creando mezclas de gusto contemporáneo. Combinando acabados y colores es posible personalizar su estilo, enriqueciéndolo con nuevas presentaciones y efectos insólitos.

Die Serie von Spezialoberflächen kann auch auf Geschirrprodukte angewendet werden. Auf diese Weise man kann Kombinationen mit einem zeitgemäßen Geschmack erschaffen. Durch die Kombination von Oberflächen und Farben können Sie Ihren eigenen Stil anpassen und ihn mit neuer Kleidung und ungewöhnlichen Effekten bereichern.

Vasellame - Hollowware

Finiture speciali - Special Finishes

La gamma di finiture speciali può essere applicata anche ai prodotti di vasellame, creando combinazioni dal gusto contemporaneo. Abbinando finiture e colori è possibile personalizzare il proprio stile, arricchendolo con vesti nuove ed effetti inconsueti.



PVD oro

Mirror PVD Gold
cod. ...41



PVD rame

Mirror PVD Copper
cod. ...40



PVD nero

Mirror PVD Black
cod. ...42



PVD champagne

Mirror PVD Champagne
cod. ...80





**Polvere di Luna
PVD oro**

Moon dust PVD Gold
cod. ... 35



**Polvere di Luna
PVD rame**

Moon dust PVD Copper
cod. ...53



**Polvere di Luna
PVD nero**

Moon dust PVD Black
cod. ...39



**Polvere di Luna
PVD champagne**

Moon dust PVD Champagne
cod. ...78





Vintage PVD oro

Vintage PVD Gold
cod. ...57



Vintage PVD rame

Vintage PVD Copper
cod. ...56

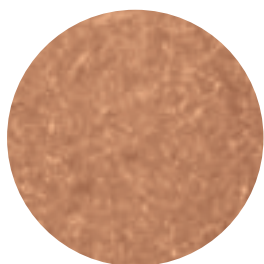

Vintage PVD nero

Vintage PVD Black
cod. ...58

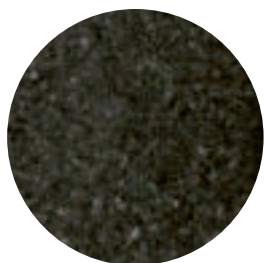



ACCESSORIES



ACCESSORIES





Yummy

Inox 18/10 - St. Steel - 2,2 mm
Cod. CBB..

COD. CBB..		L. mm
	Cucchiaio Bimbo	
68		160
	Forchetta Bimbo	
69		160
	Coltello Bimbo	
70		160

Piattino appetizer tondo con manico

Appetiser saucer, round, with handle
 Soucoupe mise en bouche ronde avec poignée
 Platito aperitivo redondo con mango
 Vorspeisenteller, rund, mit Henkel

Acciaio Inox 18/10 - St. Steel 18/10

	ø cm	ø in
903 05 81 AP3	8	3,1/8

Scotch Brite Oro - Scotch Brite Gold - 903 88 81 AP3



Piattino appetizer quadrato con manico angolare

Appetiser saucer, square, with angular handle
 Soucoupe mise en bouche ronde avec poignée angulaire
 Platito aperitivo cuadrado con mango angular
 Vorspeisenteller, quadratisch, mit eckigem Griff

Acciaio Inox 18/10 - St. Steel 18/10

	cm	in
903 05 81 AP2	8 x 8	3,1/8 x 3,1/8

Scotch Brite Oro - Scotch Brite Gold - 903 88 81 AP2



Piattino appetizer rettangolare con manico

Appetiser saucer, rectangular, with handle
 Soucoupe mise en bouche rectangulaire avec poignée
 Platito aperitivo rectangular con mango
 Vorspeisenteller, rechteckig, mit Henke

Acciaio Inox 18/10 - St. Steel 18/10

	cm	in
903 05 81 AP1	13 x 3,8	5,1/8 x 1,3/8

Scotch Brite Oro - Scotch Brite Gold - 903 88 81 AP1



Piattino appetizer quadrato con manico

Appetiser saucer, square, with handle
 Soucoupe mise en bouche ronde avec poignée
 Platito aperitivo cuadrado con mango
 Vorspeisenteller, quadratisch, mit Griff

Acciaio Inox 18/10 - St. Steel 18/10

	cm	in
903 05 81 AP6	8 x 8	3,1/8 x 3,1/8

Scotch Brite Oro - Scotch Brite Gold - 903 88 81 AP6







Poggiaposate Tube 2 Posizioni

Tube 2-Position Cutlery Rest
 Porte-couverts Tube à 2 positions
 Tube 2-Position Besteckauflage
 Cubertero Tubo 2 Posiciones

Acciaio Inox 18/10 - St. Steel

	∅ cm	∅ in	H cm	H in
903 05 84 680	2	3/4	5,6	2,1/8

Oro - Gold 903 41 84 680

Nero - Black 903 42 84 680



Poggiaposate Tube 3 Posizioni

Tube 3-Position Cutlery Rest
 Porte-couverts Tube à 3 positions
 Tube 3-Position Besteckauflage
 Cubertero Tubo 3 Posiciones

Inox 18/10 - St. Steel

	∅ cm	∅ in	H. cm	H. in
903 05 84 681	2	3/4	10,5	4,1/8

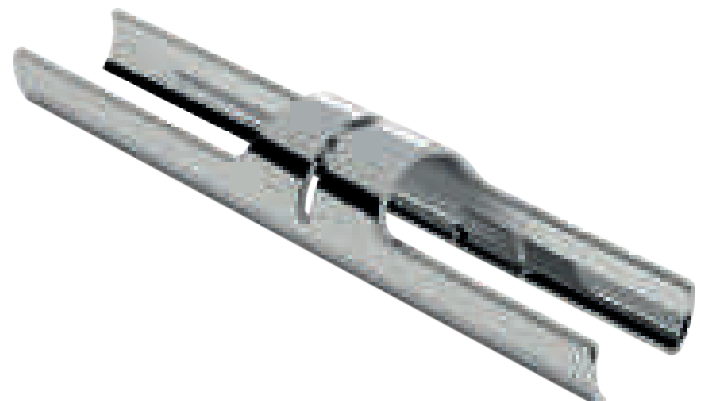

Poggiaposate rotondo

Round cutlery stand
 Porte-couverts rond
 Bestek bänke rund
 Posa cubiertos redondo

Inox 18/10 - St. Steel

	ø mm	ø in
903 05 84 670	100	3,9

Vintage 903 51 84 670

Vintage copper 903 56 84 670

Vintage Gold 903 57 84 670

**Legatovaglioli tondo**

Round napkin ring
 Rond de serviette
 Serviettenhalter
 Servilletero redondo

Inox 18/10 - St. Steel

	ø mm	ø in
V01 05 81 001	40	1,2/3

**Legatovaglioli / poggiabastoncini Bamboo**

Bamboo napkin ring / cutlery stand
 Rond de serviettes / porte - couverts Bamboo
 Serviettenhalter / posa cubiertos, Bamboo
 Servilletero / besteck bänke Bamboo

Inox 18/10 - St. Steel

	mm	H. mm	in	H In
V01 05 81 005	60x35	40	2.3/8x1,3/8	1,1/2

Disegnato da Tianshu Shi e Mengdi Xu



Bacchette sushi Square

Square sushi chopsticks
 Baguettes à sushi Square
 Square Sushi stäbchen
 Palillos para sushi Square

Inox 18/10 - St. Steel

	mm	in
903 05 84 663	230	9
Set 2 pz – 2-pc set		

**Bacchette sushi Ergo**

Ergo sushi chopsticks
 Baguettes à sushi Ergo
 Ergo Sushi stäbchen
 Palillos para sushi Ergo

Inox 18/10 - St. Steel

	mm	in
903 05 84 660 X	230	9
Set 2 pz – 2-pc set		

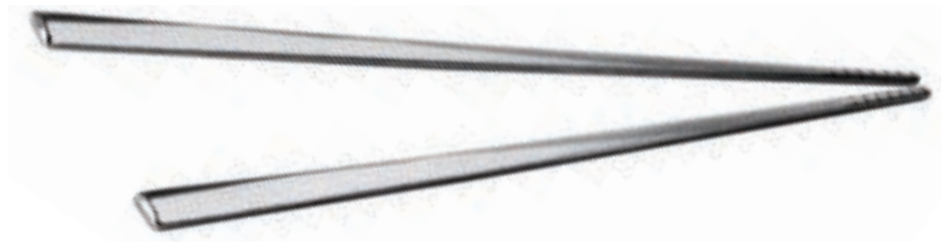
**Poggiabastoncini Ergo**

Ergo Cutlery stand
 Porte - couverts Ergo
 Ergo Besteck Bänke
 Posa cubiertos Ergo

Inox 18/10 - St. Steel

	mm	in
903 05 84 662	60	2,3/8



Cucchiaino cereali

Cereal spoon
Cuillère à céréales
Cerealienlöffel
Cuchara de cereales

Acciaio Inox 18/10 - St. Steel 18/10

	mm	in
908 05 00 006	185	7,1/4

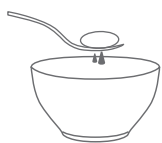

Cucchiaino tè/moka

Tea spoon
Cuillère à moka
Tee-/Mokalöffel
Cuchara de moka

Acciaio Inox 18/10 - St. Steel 18/10

	mm	in
908 05 00 003	120	4,3/4



Paletta miscelatore

Coffee stirrer
Agitateur à café
Kaffee-Rührer
Paleta café

Acciaio Inox 18/10 - St. Steel 18/10

	mm	in
908 05 00 005	100	4



Cucchiaino spatolina

Spatula spoon
Cuillère spatule
Spatel - Spatenlöffel
Cuchinilla spatula

Acciaio Inox 18/10 - St. Steel 18/10

	mm	in
908 05 00 002	149	6



Cucchiaino yogurt/cioccolato/marmellata

Yogurt / chocolate / jam spoon
Cuillère à yaourt / chocolat / confiture
Joghurt / Schokoladen / Marmeladenlöffel
Cuchara yogur / chocolate / mermelada

Acciaio Inox 18/10 - St. Steel 18/10

	mm	in
908 05 00 001	121	4,3/4



Cucchiaino servi miele con piega

S-shaped honey serving spoon
Cuillère à miel pliée
Gebogener Honiglöffel
Cuchara para miel plegada

Acciaio Inox 18/10 - St. Steel 18/10

	mm	in
C89 390	140	5,1/2





Appetizer Double (cucchiaino forchettina)

Double appetizer (spoon fork)
 Cuillère de mise en bouche Double (cuillère fourchette)
 Appetizerlöffel doppelt (Löffel & Gabel)
 Aperitivo Double (cuchara tenedor)

Acciaio Inox 18/10 - St. Steel 18/10

	mm	in
CF7 PDFS	122	4,3/4

**Cucchiaino moka appetizer con foro Linea**

Linea moka spoon appetizer with hole
 Cuillère à moka de mise en bouche avec trou Linea
 Appetizer Mokälöffel mit Loch Linea
 Cuchara moka aperitivo con agujero Linea

Acciaio Inox 18/10 - St. Steel 18/10

	mm	in
CF7P 22F	106	4,1/8

**Cucchiaino caffè' appetizer Linea**

Linea tea spoon appetizer
 Cuillère à thé de mise en bouche Linea
 Appetizer Kaffee/Teelöffel Linea
 Cuchara café aperitivo Linea

Acciaio Inox 18/10 - St. Steel 18/10

	mm	in
CF7P 21	122	4,3/4

**Forchetta 2 punte appetizer Linea**

Linea fork appetizer, two-prong
 Fourchette de mise en bouche à deux dents Linea
 Appetizer Zweizinkengabel Linea
 Tenedor aperitivo dos puntas Linea

Acciaio Inox 18/10 - St. Steel 18/10

	mm	in
CF7P 63	105	4,1/8

**Cucchiaino moka appetizer Linea**

Linea moka spoon appetizer
 Cuillère à moka de mise en bouche Linea
 Appetizer Mokälöffel Linea
 Cuchara moka aperitivo Linea

Acciaio Inox 18/10 - St. Steel 18/10

	mm	in
CF7P 22	106	4,1/8

**Cucchiaino bibita appetizer Linea**

Linea cocktail spoon
 Cuillère à mazagran Linea
 Cocktaillöffel Linea
 Cuchara refresco Linea

Acciaio Inox 18/10 - St. Steel 18/10

	mm	in
CF7P 35	210	8,1/4



Cucchiaino caffè Svezia

Svezia coffee spoon
 Cuillère à café Svezia
 Kaffee/Teelöffel Svezia
 Cuchara café Svezia

Acciaio Inox - St. Steel

	mm	in
CSV 21	140	5,1/2

**Cucchiaino bibita Svezia**

Svezia cocktail spoon
 Cuillère à cocktail Svezia
 Cocktaillöffel Svezia
 Cuchara refresco Svezia

Acciaio Inox - St. Steel

	mm	in
CSV 35	204	8

**Cucchiaino moka Svezia**

Svezia moka spoon
 Cuillère à moka Svezia
 Mokalöffel Svezia
 Cuchara moka Svezia

Acciaio Inox - St. Steel

	mm	in
CSV 22	105	4,1/8

**Cucchiaino gelato Svezia**

Svezia ice cream spoon
 Cuillère à glace Svezia
 Eislöffel Svezia
 Cuchara helado Svezia

Acciaio Inox - St. Steel

	mm	in
CSV 37	131	5,1/8

**Forchetta dolce Svezia**

Svezia cake fork
 Fourchette à gâteau Svezia
 Kuchengabel Svezia
 Tenedor lunch Svezia

Acciaio Inox - St. Steel

	mm	in
CSV 38	145	5,3/4



Cucchiaino moka Riflesso

Riflesso moka spoon
Cuillère à moka Riflesso
Mokalöffel Riflesso
Cuchara moka Riflesso

Acciaio Inox 18/10 - St. Steel 18/10

	mm	in
C33P 22	108	4,3/8



Cucchiaino caffè Riflesso

Riflesso coffee spoon
Cuillère à café Riflesso
Kaffee/Teelöffel Riflesso
Cuchara café Riflesso

Acciaio Inox 18/10 - St. Steel 18/10

	mm	in
C33P 21	130	5,7/8



Paletta gelato Riflesso

Riflesso ice cream spoon
Cuillère à glace Riflesso
Eislöffel Riflesso
Cuchara helado Riflesso

Acciaio Inox 18/10 - St. Steel 18/10

	mm	in
C33P 37	130	5,1/8



Cucchiaino bibita Riflesso

Riflesso cocktail spoon
Cuillère à cocktail Riflesso
Cocktaillöffel Riflesso
Cuchara refresco Riflesso

Acciaio Inox 18/10 - St. Steel 18/10

	mm	in
C33P 35	201	7,7/8



Cucchiaino caffè con piega Riflesso

Riflesso s-shaped tea spoon
Cuillère à thé pliée
Riflesso - Gebogener Teelöffel Riflesso
Cucharita café plegada Riflesso

Acciaio Inox 18/10 - St. Steel 18/10

	mm	in
C33P 392	115	4,1/2



Cucchiaino bibita con piega Riflesso

Riflesso s-shaped cocktail spoon
Cuillère à mazagran pliée Riflesso
Gebogener Cocktaillöffel Riflesso
Cuchara refresco plegada Riflesso

Acciaio Inox 18/10 - St. Steel 18/10

	mm	in
C33P 394	185	7,1/4



Forchettina dolce Riflesso

Riflesso cake fork
 Fourchette à gâteau Riflesso
 Kuchengabel Riflesso
 Tenedor lunch Riflesso

Acciaio Inox 18/10 - St. Steel 18/10

	mm	in
C33P 38	144	5,3/4

**Forchettina 2 punte Riflesso**

Riflesso two-prong fork
 Fourchette à deux dents Riflesso
 Zweizinkengabel Riflesso
 Tenedor dos puntas Riflesso

Acciaio Inox 18/10 - St. Steel 18/10

	mm	in
C33P 63	144	5,3/4

**Cucchiaino fragola e confetti Milord**

Milord sweet spoon
 Cuillère à sucreries Milord
 Erdbeer- und Konfektlöffel Milord
 Cuchara para dulces Milord

Acciaio Inox 18/10 - St. Steel 18/10

	mm	in
C14 36	170	6,5/8

**Cucchiaino fragola e confetti Imperial**

Imperial sweet spoon
 Cuillère à sucreries Imperial
 Erdbeer- und Konfektlöffel Imperial
 Cuchara para dulces Imperial

Acciaio Inox 18/10 - St. Steel 18/10

	mm	in
C04 36	170	6,5/8

**Cucchiaino olive con fori**

Olive slotted spoon
 Cuillère de mise en bouche olives perforée
 Gelochter Oliven Löffel
 Cuchara aceitunas perforada

Acciaio Inox 18/10 - St. Steel 18/10

	mm	in
903 05 81 AOF	225	8,7/8

**Cucchiaino olive**

Olive spoon
 Cuillère de mise en bouche olives
 Oliven Löffel
 Cuchara aceitunas

Acciaio Inox 18/10 - St. Steel 18/10

	mm	in
903 05 81 AOL	225	8,7/8



Cucchiaino moka 903

903 Moka spoon
Cuillère à moka 903
Mokalöffel 903
Cuchara moka 903

Acciaio Inox - St. Steel

	mm	in
903 06 81 024	111	4,3/8



Cucchiaino ghiaccio Matisse piccolo

Matisse slotted ice spoon
Cuillère à glaçons perforée Matisse
Kleiner Eiswürfelloffel Matisse
Cuchara hielo perforada Matisse

Acciaio Inox 18/10 - St. Steel 18/10

	mm	in
CF1 251	170	6,5/8



Cucchiaino multiuso Matisse grande

Matisse slotted spoon large
Cuillère à servir perforée Matisse grande
Großer Universallöffel Matisse
Cuchara para servir perforada Matisse grande

Acciaio Inox 18/10 - St. Steel 18/10

	mm	in
CF1 162	205	8,1/8



Mestolino unipezzo yogurt/salsa

Yogurt/sauce ladle, small
Louche à sauce en une pièce
Schopflöffel klein einteilig
Cacillo salsa de una sola pieza

Acciaio Inox 18/10 - St. Steel 18/10

	mm	in
C1108446	174	6,7/8



Forchettina appetizer segnaposto

Place-card appetizer fork

Fourchette de mise en bouche marque-place

Tischkarte Appetizer Gabel

Tenedor aperitivo etiqueta

Acciaio Inox 18/10 - St. Steel 18/10

	H. mm	H. in
903 05 81 APF	97	3,7/8

Double

Double

Double

Doppel

Double

Acciaio Inox 18/10 - St. Steel 18/10

	mm	in
903 05 81 DFS	165	6,1/2

Appetizer Matisse con riccio

Matisse curled appetizer

Cuillère de mise en bouche en boucle

Appetizerlöffel

Aperitivo con nudo - cuchara

Acciaio Inox 18/10 - St. Steel 18/10

		mm	in
CF1 CR	SPOON	141	5,1/2
CF1 FR	FORK	136	5,3/8

Appetizer Brigitte con piega

Bended appetizer spoon Brigitte

Mise en bouche pliée Brigitte

Appetizerlöffel Brigitte

Aperitivo plegada Brigitte

Acciaio Inox 18/10 - St. Steel 18/10

		mm	in
C68 CP	SPOON	142	5,1/2
C68 FP	FORK	142	5,1/2



Tapas Matisse

Matisse Tapas
 Cuillère Tapas Matisse
 Tapas Matisse
 Tapas Matisse

Acciaio Inox 18/10 - St. Steel 18/10

	mm	in
CF1 TA	170	6,3/4



Cucchiaio appetizer tondo

Appetizer curved spoon
 Cuillère de mise en bouche ronde pliée
 Appetizer - rund gebogener Löffel
 Cuchara aperitivo redonda plegada

Acciaio Inox 18/10 - St. Steel 18/10

	mm	in
903 05 81 APC	140	5,1/2



Mini appetizer Ego

Ego mini appetizer
 Mini mise en bouche Ego
 Mini Appetizer Ego
 Mini aperitivo Ego

Acciaio Inox 18/10 - St. Steel 18/10

	mm	in	
CD3 22	115	4,1/2	SPOON
CD3 38M	115	4,1/2	FORK





Coltello carne Modern seghettato

Modern steak knife, serrated-edge
 Couteau à bifteck Modern à lame dentelée
 Modern Steakmesser
 Cuchillo carne Modern filo dentado

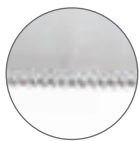

Acciaio Inox - St. Steel / ABS

	mm	in
903 06 86 A	227	9

Coltello carne Modern filo rasoio

Modern steak knife, plain-edge
 Couteau à bifteck Modern à lame rasoir
 Modern Steakmesser
 Cuchillo carne Modern filo liso



Acciaio Inox - St. Steel / ABS

	mm	in
903 06 86 B	227	9

Coltello Angus seghettato

Angus steak knife, serrated-edge
 Couteau à bifteck Angus à lame dentelée
 Angus Steakmesser
 Cuchillo carne Angus filo dentado

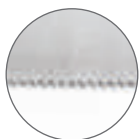

Acciaio Inox - St. Steel / POM

	mm	in
CAN 55	229	9

Coltello Angus filo rasoio

Angus steak knife, plain-edge
 Couteau à bifteck Angus à lame rasoir
 Angus Steakmesser
 Cuchillo carne Angus filo liso



Acciaio Inox - St. Steel / POM

	mm	in
CAN 55R	229	9

**Coltello carne Safari
seghettato - serrated blade**

Safari steak knife
Couteau à bifteck Safari à lame dentelée
Safari Steakmesser
Cuchillo carne Safari filo dentado



Acciaio Inox - St. Steel
Legno - Wood

	mm	in
CE5 A5 5LC	235	9,1/4

**Coltello carne Texas
filo rasoio - razor-edge**

Texas steak knife
Couteau à bifteck Texas à lame rasoir
Texas Steakmesser
Cuchillo carne Texas filo liso



Acciaio Inox - St. Steel
Legno - Wood

	mm	in
CAN 55 LCR	235	9,1/4

**Coltello carne Memphis
seghettato - serrated blade**

Memphis steak knife
Couteau à bifteck Memphis
Memphis Steakmesser
Cuchillo carne Memphis



Acciaio Inox - St. Steel
Legno - Wood

	mm	in
CKO 55 LC	250	9.7/8

Coltello carne Kobe

Kobe steak knife
 Couteau à bifteck Kobe
 Kobe Steakmesser
 Cuchillo carne Kobe



Acciaio Inox - St. Steel
Legno - Wood

	mm	in
CKO 55	244	9,5/8

Coltello carne Kobe

Kobe steak knife
 Couteau à bifteck Kobe
 Kobe Steakmesser
 Cuchillo carne Kobe

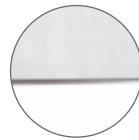

Acciaio Inox - St. Steel
Legno - Wood

	mm	in
CKO 55R	244	9,5/8

Coltello carne Fuego

Fuego steak knife
 Couteau à bifteck Fuego
 Fuego Steakmesser
 Cuchillo carne Fuego



Acciaio Inox - St. Steel / ABS

	mm	in
CFU 55	232	9

Coltello carne Fuego

Fuego steak knife
 Couteau à bifteck Fuego
 Fuego Steakmesser
 Cuchillo carne Fuego

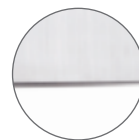

Acciaio Inox - St. Steel / ABS

	mm	in
CFU 55R	232	9

Coltello carne Kansas

Kansas steak knife
 Couteau à bifteck Kansas
 Kansas Steakmesser
 Cuchillo carne Kansas

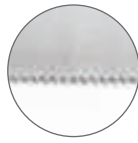

Acciaio Inox - St. Steel / POM

	mm	in
CKA 55	218	8,5/8

Blister coltelli carne Rost punta

Rost steak knives blister
 Blister de couteaux à viande Rost
 Fleischmesser Rost Blisterpackung
 Blister cuchillos carne Rost

	pcs	mm	in
AVARI 064B 06	6	210	8,1/4
AVARI 064B 12	12	210	8,1/4



Blister coltelli carne Rost punta tonda

Blister of Rost steak knives, rounded tip
 Blister de couteaux à viande Rost pointe ronde
 Fleischmesser Rost Blisterpackung
 Blister cuchillos carne Rost punta redonda

	pcs	mm	in
AVARI 064T B06	6	212	8,1/4
AVARI 064T B12	12	212	8,1/4



Blister coltelli pizza Rost

Pizza knives Rost blister
 Blister de couteaux à pizza Rost
 Rost Pizzamesser Blisterpackung
 Blister cuchillos pizza Rost

	pcs	mm	in
AVARI 064P B06	6	200	7,7/8
AVARI 064P B12	12	200	7,7/8



Coltello fiorentina

Fiorentina steak knife
 Couteau à bifteck Fiorentina
 Fiorentina Steakmesser
 Cuchillo carne Fiorentina

Acciaio Inox - St. Steel

	mm	in
CFI 55	230	9



Forchetta fiorentina

Fiorentina steak fork
 Fourchette à bifteck Fiorentina
 Fiorentina Steakgabel
 Tenedor carne Fiorentina

Acciaio Inox 18/10 - St. Steel 18/10

	mm	in
CFI 02	204	8



Coltello carne Malaga

Malaga steak knife
 Couteau à bifteck Malaga
 Malaga Fleischmesser
 Cuchillo carne Malaga

Acciaio Inox - St. Steel

	mm	in
CMA 55	231	8,5/8



Forchetta carne Altozano/Malaga

Altozano steak fork
 Fourchette à bifteck Altozano
 Altozano Steakgabel
 Tenedor carne Altozano

Acciaio Inox 18/10 - St. Steel 18/10

	mm	in
CAL 52	205	8



Coltello carne Pampero / C

Pampero steak knife
 Couteau à bifteck Pampero
 Pampero Steakmesser
 Cuchillo carne Pampero

Acciaio Inox - St. Steel

	mm	in
CPP 55 C	222	8,5/8



Pampa forchetta carne

Pampa steak fork
 Fourchette à bifteck
 Carne/Bistecca Tenedor chuletero
 Pampa Pampa Steakgabel

Acciaio inox - St-Steel

	mm	in
CPA52C	197	7,7/8



Coltello pizza carne Azzurra

Azzurra pizza knife
 Couteau à pizza Azzurra
 Azzurra Pizzamesser
 Cuchillo pizza Azzurra

Acciaio Inox - St. Steel

	mm	in
CZ 7134	225	8,7/8



Forchetta pizza Azzurra

Azzurra pizza fork
 Fourchette à pizza Azzurra
 Azzurra Pizzagabel
 Tenedor pizza Azzurra

Acciaio Inox - St. Steel

	mm	in
CZ 752	200	7,7/8



Coltello pizza Modern acciaio

Modern pizza knife
 Couteau à pizza Modern
 Modern Pizzamesser
 Cuchillo pizza Modern

Acciaio Inox - St. Steel

	mm	in
CPI 05P	205	8



Forchetta pizza Modern acciaio

Modern pizza fork
 Fourchette à pizza Modern
 Modern Pizzagabel
 Tenedor pizza Modern

Acciaio Inox - St. Steel

	mm	in
CPI 02 CR	203	7,7/8



Coltello carne Modern acciaio

Modern steak knife
 Couteau à bifteck Modern
 Modern Steakmesser
 Cuchillo carne Modern

Acciaio Inox - St. Steel

	mm	in
CPI 05	226	8,7/8



Coltello pizza Palio

Pizza knife Palio
 Couteau à pizza Palio
 Palio Pizzamesser
 Cuchillo pizza Palio

Acciaio Inox - St. Steel

	mm	in
CC3 134	210	8,1/4



Forchetta carne Ergo

Ergo steak fork
 Fourchette à bifteck Ergo
 Ergo Steakgabel
 Tenedor carne Ergo

Acciaio inox 18/10 - St-Steel 18/10

	mm	in
CE552	210	8,1/4



Coltello carne Pampero

Pampero steak knife
 Couteau à bifteck Pampero
 Pampero Steakmesser
 Cuchillo carne Pampero

Acciaio Inox - St. Steel

	mm	in
CPP 55	222	8,5/8



Coltello carne Flair

Flair steak knife
 Couteau à bifteck FLair
 Flair Steakmesser
 Cuchillo carne Flair

Acciaio Inox - St. Steel

	mm	in
C0255	220	8,5/8



Coltello carne Milord

Milord steak knife
 Couteau à bifteck Milord
 Milord Steakmesser
 Cuchillo carne Milord

Acciaio Inox - St. Steel

	mm	in
C1455	233	9



Coltello carne Victory

Victory steak knife
 Couteau à bifteck Victory
 Victory Steakmesser
 Cuchillo carne Victory

Acciaio Inox - St. Steel

	mm	in
CP255	230	9



Pinza aragosta forgiata

Lobster cracker, forged
Pince à homard forgé
Langustezange - geschmieden
Pinzas langosta forjadas

Acciaio Inox - St. Steel

	mm	in
305 05 91 658	190	7,1/2

**Stiletto aragosta**

Lobster pick
Fourchette à homard
Langustegabel
Tenedor langosta

Acciaio Inox 18/10 - St. Steel 18/10

	mm	in
903 05 84 659	202	7,7/8

**Forchettina ostriche**

Oyster fork
Fourchette à crustacés
Austerngabel
Tenedor ostras

Acciaio Inox 18/10 - St. Steel 18/10

	mm	in
CF1 64	156	6,1/8

**Stiletto ostriche/crostacei**

Oyster fork
Fourchette à crustacés
Krustengabel
Tenedor mariscos

Acciaio Inox 18/10 - St. Steel 18/10

	mm	in
CPA 64	227	8,7/8

**Forchettina 2 punte Matisse**

Matisse fork, two-prong
Fourchette à deux dents Matisse
Zweizinkengabel Matisse
Tenedor dos puntas Matisse

Acciaio Inox 18/10 - St. Steel 18/10

	mm	in
CF1 63	156	3,1/8

**Molla lumache**

Snail tongs
Pince à escargots
Schneckenzange
Pinzas caracoles

Acciaio Inox - St. Steel

	mm	in
903 05 81 MLU	160	6,1/4



Coltello formaggi cremosi Regis Spalmy

Spalmy creamy cheese knife
 Couteau à fromages crèmeux Spalmy
 Schmelzkäsemesser Spalmy
 Cuchillo quesos cremosos Spalmy

Acciaio Inox - St. Steel

	mm	in
903 05 84D	225	8,7/8

**Coltello paste molli Regis Tommy**

Tommy tender cheese knife
 Couteau à fromages à pâte molle Tommy
 Weichkäsemesser Tommy
 Cuchillo quesos pasta blanda Tommy

Acciaio Inox - St. Steel

	mm	in
903 05 84A	218	8,5/8

**Coltello 2 punte Regis Emmy**

Emmy medium-hard cheese knife
 Couteau à fromages à pâte demi-ferme Emmy
 Milderkäsemesser Emmy
 Cuchillo quesos pasta semi-dura Emmy

Acciaio Inox - St. Steel

	mm	in
903 05 84B	221	8,5/8

**Coltello formaggi di paste crude Regis Parmy**

Parmy hard cheese knife
 Couteau à fromages à pâte ferme Parmy
 Hartkäsemesser Parmy
 Cuchillo quesos pasta dura Parmy

Acciaio Inox - St. Steel

	mm	in
903 05 84C	199	7,7/8

**Coltello formaggelle Regis Formy**

Formy formaggelle soft cheese knife
 Couteau à fromages à pâte molle formaggelle Formy
 Frischkäsemesser Formy
 Cuchillo quesos pasta blanda formaggelle Formy

Acciaio Inox - St. Steel

	mm	in
903 05 84E	273	10,5/8

**Affettaformaggio Regis**

Regis cheese slicer
 Pelle coupe-fromage Regis
 Käsehobel Regis
 Pala corta queso Regis

Acciaio Inox - St. Steel

	mm	in
903 05 84 135	190	7,1/2





Forchettone arrosto manico vuoto Lux

Roast serving fork hollow handle
 Grande fourchette rôti, manche creuse
 Fleischgabel, hohem Heft
 Tenedor asado, mango hueco

Acciaio Inox - St. Steel

	mm	in
903 05 91 MV2	275	11,1/4



Coltello arrosto manico vuoto Lux

Roast serving knife hollow handle
 Couteau à bifteck, manche creuse
 Filetmesser, hohem Heft
 Cuchillo carne, mango hueco

Acciaio Inox - St. Steel

	mm	in
903 05 91 MV3	315	12,3/8



Coltello pane/panettone Lux

Panettone knife hollow handle
 Couteau à tarte lame denteleé, manche creuse
 Kuchenmesser, hohem Heft
 Cuchillo pastel dentado, mango hueco

Acciaio Inox - St. Steel

	mm	in
903 05 91 MV1	285	11,1/4



Cucchiaine buffet Milord cm. 34

Milord buffet serving spoon, cm. 34
 Cuillère de service buffet Milord cm. 34
 Milord Buffetlöffel, cm. 34
 Cuchara para servir buffet Milord cm. 34

Acciaio Inox 18/10 - St. Steel 18/10

	mm	in
C142710	340	13,38

Cucchiaine servire Milord

Milord serving spoon
 Cuillère de service Milord
 Milord Servierlöffel
 Cuchara para servir Milord

Acciaio Inox 18/10 - St. Steel 18/10

	mm	in
C1427	227	9

Cucchiaine forato Milord

Milord serving spoon w/holes
 Cuillère de service perforée Milord
 Milord Servierlöffel, gelocht
 Cuchara para servir c/agujeros Milord

Acciaio Inox 18/10 - St. Steel 18/10

	mm	in
C1460	227	9

Cucchiaine buffet forato Milord cm. 34

Milord buffet serving spoon w/holes, cm. 34
 Cuillère de service buffet perforée Milord cm. 34
 Milord Buffetlöffel, gelocht, cm. 34
 Cucharón para servir buffet c/agujeros Milord cm. 34

Acciaio Inox 18/10 - St. Steel 18/10

	mm	in
C142720	340	13,38

Forchettone servire Milord

Milord serving fork
 Fourchette de service Milord
 Milord Serviergabel
 Tenedor para servir Milord

Acciaio Inox 18/10 - St. Steel 18/10

	mm	in
C1426	228	9

Cucchiaine insalata Milord

Milord salad serving spoon
 Cuillère a servir salade Milord
 Milord Servierlöffel Salad
 Cuchara para servir ensalada Milord

Acciaio Inox 18/10 - St. Steel 18/10

	mm	in
C1428	227	9

Forchetta insalata Milord

Milord salad serving fork
 Fourchette a servir salade Milord
 Milord Serviergabel Salad
 Tenedor para servir ensalada Milord

Acciaio Inox 18/10 - St. Steel 18/10

	mm	in
C1429	227	9



C142710

C142720



C1427



C1426



C1460



C1428



C1429

Mestolino punch Milord

Milord punch ladle
Louche à punch Milord
Milord Punchkelle
Cazo punch Milord

Acciaio Inox 18/10 - St. Steel 18/10

	mm	in
C142520	285	11,1/4

Mestolino salsa Milord

Milord sauce ladle
Louche à sauce Milord
Milord Soßenkelle
Cacillo salsa Milord

Acciaio Inox 18/10 - St. Steel 18/10

	mm	in
C1442	153	5,7/8

Pala torta Milord

Milord cake server
Pelle à gâteaux Milord
Milord Tortenheber
Pala pastel Milord

Acciaio Inox 18/10 - St. Steel 18/10

	mm	in
C1439	240	9,1/2

Mestolo servire Milord cm. 30

Milord soup ladle, cm. 30
Louche Milord cm. 30
Milord Schöpflöffel, cm. 30
Cazo sopa Milord cm. 30

Acciaio Inox 18/10 - St. Steel 18/10

	mm	in
C1425	304	12

Mestolo Milord cm. 20

Milord ladle, cm. 20
Louche Milord cm. 20
Milord Schöpflöffel, cm. 20
Cazo Milord cm. 20

Acciaio Inox 18/10 - St. Steel 18/10

	mm	in
C142510	198	7,7/8

Cucchiaione riso Milord

Milord rice serving spoon
Cuillère de service à riz Milord
Milord Servierlöffel Reis
Cuchara para servir arroz Milord

Acciaio Inox 18/10 - St. Steel 18/10

	mm	in
C1430	251	9,7/8



Cucchiaine buffet Marea cm. 34

Marea buffet serving spoon, cm. 34
 Cuillère de service buffet Marea cm. 34
 Marea Buffetlöffel, cm. 34
 Cuchara para servir buffet Marea cm. 34

Acciaio Inox 18/10 - St. Steel 18/10

	mm	in
CE42710	346	13,5/8

Cucchiaine servire Marea

Marea serving spoon
 Cuillère de service Marea
 Marea Servierlöffel
 Cuchara para servir Marea

Acciaio Inox 18/10 - St. Steel 18/10

	mm	in
CE427	228	9

Cucchiaine forato Marea

Marea serving spoon w/holes
 Cuillère de service perforée Marea
 Marea Servierlöffel, gelocht
 Cuchara para servir c/agujeros Marea

Acciaio Inox 18/10 - St. Steel 18/10

	mm	in
CE460	228	9

Cucchiaine buffet forato Marea cm. 34

Marea buffet serving spoon w/holes, cm. 34
 Cuillère de service buffet perforée Marea cm. 34
 Marea Buffetlöffel, gelocht, cm. 34
 Cucharón para servir buffet c/agujeros Marea cm. 34

Acciaio Inox 18/10 - St. Steel 18/10

	mm	in
CE42720	346	13,5/8

Forchettone servire Marea

Marea serving fork
 Fourchette de service Marea
 Marea Serviergabel
 Tenedor para servir Marea

Acciaio Inox 18/10 - St. Steel 18/10

	mm	in
CE426	237	9,1/4

Cucchiaine insalata Marea

Marea salad serving spoon
 Cuillère a servir salade Marea
 Marea Servierlöffel Salad
 Cuchara para servir ensalada Marea

Acciaio Inox 18/10 - St. Steel 18/10

	mm	in
CE428	228	9

Forchetta insalata Marea

Marea salad serving fork
 Fourchette a servir salade Marea
 Marea Serviergabel Salad
 Tenedor para servir ensalada Marea

Acciaio Inox 18/10 - St. Steel 18/10

	mm	in
CE429	229	9



CE42710

CE42720



CE427



CE426



CE460



CE428



CE429

Mestolino punch Marea

Marea punch ladle
 Louche à punch Marea
 Marea Punchkelle
 Cazo punch Marea

Acciaio Inox 18/10 - St. Steel 18/10

	mm	in
CE42520	283	11

Mestolino salsa Marea

Marea sauce ladle
 Louche à sauce Marea
 Marea Soßenkelle
 Cacillo salsa Marea

Acciaio Inox 18/10 - St. Steel 18/10

	mm	in
CE442	152	5,7/8

Pala torta Marea

Marea cake server
 Pelle à gâteaux Marea
 Marea Tortenheber
 Pala pastel Marea

Acciaio Inox 18/10 - St. Steel 18/10

	mm	in
CE439	250	9,7/8

Mestolo servire Marea cm. 30

Marea soup ladle, cm. 30
 Louche Marea cm. 30
 Marea Schöpflöffel, cm. 30
 Cazo sopa Marea cm. 30

Acciaio Inox 18/10 - St. Steel 18/10

	mm	in
CE425	305	12

Mestolo Marea cm. 20

Marea ladle, cm. 20
 Louche Marea cm. 20
 Marea Schöpflöffel, cm. 20
 Cazo Marea cm. 20

Acciaio Inox 18/10 - St. Steel 18/10

	mm	in
CE42510	202	7,7/8

Cucchiaione riso Marea

Marea rice serving spoon
 Cuillère de service à riz Marea
 Marea Servierlöffel Reis
 Cuchara para servir arroz Marea

Acciaio Inox 18/10 - St. Steel 18/10

	mm	in
CE430	264	10,3/8



CE42520

CE425

CE442

CE42510

CE439

CE430

Cucchiaine riso professionale

Professional rice-serving spoon
Cuillère à riz professionnelle
Reislöffel
Cucharón arroz profesional

Acciaio Inox 18/10 - St. Steel 18/10

	mm	in	spessore / thickness
903 05 91 795	256	10	2,5 mm



Pala fritto professionale

Professional frying palette
Pelle à friture professionnelle
Schaufel
Pala frito profesional

Acciaio Inox 18/10 - St. Steel 18/10

	mm	in	spessore / thickness
903 05 91 062	295	11,5/8	2.5 mm



Cucchiaine forata professionale

Professional slotted serving spoon
Cuillère perforée professionnelle
Gelochter Löffel
Cucharón servir perforado profesional

Acciaio Inox 18/10 - St. Steel 18/10

	mm	in	spessore / thickness
903 05 91 796	290	11,1/2	2,5 mm



Cucchiaine ghiaccio professionale

Professional ice-serving spoon
Cuillère à glaçons professionnelle
Eislöffel
Cucharón hielo profesional

Acciaio Inox 18/10 - St. Steel 18/10

	mm	in	spessore / thickness
903 05 91 063	290	11,1/2	2.5 mm



Cucchiaine insalata professionale

Professional salad-serving spoon
Cuillère à salade professionnelle
Salatlöffel
Cucharón ensalada profesional

Acciaio Inox 18/10 - St. Steel 18/10

	mm	in	spessore / thickness
903 05 91 066	285	11,1/4	2,5 mm



Cucchiaine servire professionale

Professional serving spoon
Cuillère à servir professionnelle
Löffel
Cucharón servir profesional

Acciaio Inox 18/10 - St. Steel 18/10

	mm	in	spessore / thickness
903 05 91 793	290	11,1/2	2.5 mm



Cucchiaino riso forato professionale

Professional rice-serving spoon
Cuillère à riz professionnelle
Reislöffel
Cucharón arroz profesional

Acciaio Inox 18/10 - St. Steel 18/10

	mm	in	spessore / thickness
903 05 91 795 F	256	10	2,5 mm



Mestolo professionale

Professional ladle
Louche professionnelle
Professionelle Schöpfkelle
Cazo profesional

Acciaio Inox 18/10 - St. Steel 18/10

	mm	in	spessore / thickness
903 05 91 025	288	11,3/4	2.5 mm



Forchettone servire professionale

Professional serving fork
Fourchette à servir professionnelle
Gabel
Tenedor servir profesional

Acciaio Inox 18/10 - St. Steel 18/10

	mm	in	spessore / thickness
903 05 91 794	294	11,5/8	2.5 mm



Forchettone arrosto professionale

Professional carving fork
Grande fourchette rôti professionnelle
Fleischgabel
Tenedor asado profesional

Acciaio Inox 18/10 - St. Steel 18/10

	mm	in	spessore / thickness
903 05 91 064	285	11,1/4	2.5 mm



Pala gratin professionale

Professional gratin server
Pelle à gratin professionnelle
Backschaufel
Pala lasaña profesional

Acciaio Inox 18/10 - St. Steel 18/10

	mm	in	spessore / thickness
903 05 91 787	268	10,5/8	2.5 mm

seghettata / serrated

903 05 91 797	268	10,5/8	2.5 mm
---------------	-----	--------	--------



Coltello torta professionale

Professional cake knife
Couteau à gâteau professionnel
Tortenmesser
Cuchillo pastel profesional

Acciaio Inox 18/10 - St. Steel 18/10

	mm	in	spessore / thickness
903 05 91 798	297	11,3/4	2.5 mm



Coltello torta seghettato professionale

Professional serrated-edge cake knife

Couteau à gâteau professionnel lame dentelée

Kuchenmesser

Cuchillo pastel profesional dentado

Acciaio Inox 18/10 - St. Steel 18/10

	mm	in	spessore / thickness
903 05 91 788	297	11,3/4	2.5 mm
seghettato / serrated			

**Pala torta professionale**

Professional cake server

Pelle à gâteau professionnelle

Tortenschaufel

Pala pastel profesional

Acciaio Inox 18/10 - St. Steel 18/10

	mm	in	spessore / thickness
903 05 91 799	262	10,1/4	2.5 mm

**Pala torta seghettata professionale**

Professional serrated-edge cake server

Pelle à gâteau dentelée professionnelle

Tortenschaufel

Pala pastel profesional dentada

Acciaio Inox 18/10 - St. Steel 18/10

	mm	in	spessore / thickness
903 05 91 786	262	11,3/4	2.5 mm

**Spatola crepes professionale**

Professional crepes server

Spatule à crêpes professionnelle

Crepesschaufel

Pala crepes profesional

Acciaio Inox 18/10 - St. Steel 18/10

	mm	in	spessore / thickness
903 05 91 065	292	11,1/2	2.5 mm



Molla ghiaccio Lux

Lux ice tongs
Pince à glace Lux
Lux Eiszange
Pinzas hielo Lux

Acciaio Inox 18/10 - St. Steel 18/10

	mm	in
903 05 81 001	126	4,7/8
903 05 81 002	180	7



Molla insalata o vegetali Lux

Lux salad/vegetable tongs
Pince à légumes Lux
Lux Gemüsezange
Pinza para ensalada Lux

Acciaio Inox 18/10 - St. Steel 18/10

	mm	in
903 05 81 004	210	8,1/4



Molla pane Lux

Lux bread tongs
Pince à pain Lux
Lux Brotzange
Pinzas pan Lux

Acciaio Inox 18/10 - St. Steel 18/10

	mm	in
903 05 81 007	210	8,1/4



Forbici servire pane Lux

Lux bread serving scissors tongs
Pince ciseaux à servir pain Lux
Lux Brot Servierzange
Pinzas tijeras para servir pan Lux

Acciaio Inox 18/10 - St. Steel 18/10

	mm	in
903 05 81 FPA	250	8,7/8



Forbici servire pasticceria Lux

Lux pastry serving scissors
Ciseaux à servir gâteau Lux
Tijeras para servir pastelería Lux
Lux Gebäck-Servierzange

Acciaio Inox 18/10 - St. Steel 18/10

	mm	in
903 05 81 FPS	210	8,1/4



Forbici servire arrosto Lux

Lux roast serving scissors tongs
Ciseaux à servir rôti Lux
Tijeras para servir asado Lux
Lux Fleisch-Servierzange

Acciaio Inox 18/10 - St. Steel 18/10

	mm	in
903 05 81 FAR	250	8,7/8



Molla arrosto Modern

Modern roast tongs
Pince à rôti Modern
Modern fleischzange
Pinzas asado Modern

Acciaio Inox - St. Steel

	mm	in
903 05 81 MAR	250	8,7/8



Molla dolci Modern

Modern cake tongs
Pince à gâteaux Modern
Modern gebäckzange
Pinzas postre Modern

Acciaio Inox - St. Steel

	mm	in
903 05 81 MDO	250	8,7/8



Molla ghiaccio Modern

Modern ice tongs
Pince à glaçons Modern
Modern eiszange
Pinzas hielo Modern

Acciaio Inox - St. Steel

	mm	in
903 05 81 MGH	200	7,7/8



Molla spaghetti Modern

Modern spaghetti tongs
Pince à spaghetti Modern
Modern spaghettizange
Pinzas spaghetti Modern

Acciaio Inox - St. Steel

	mm	in
903 05 81 MSP	250	8,7/8



Molla insalata Long

Long salad tongs
Pince à salade Long
Long salatizange
Pinzas ensalada Long

Acciaio Inox - St. Steel

	mm	in
903 05 81 MIN	270	10,5/8



Molla pasta Long

Long pasta tongs
Pince à pâtes Long
Long pastazange
Pinzas pasta Long

Acciaio Inox - St. Steel

	mm	in
903 05 81 MPA	270	10,5/8



Molla multiuso Long

Long multipurpose tongs
Pince à servir Long
Long multipurposezange
Pinzas para servir Long

Acciaio Inox - St. Steel

	mm	in
903 05 81 MMU	295	11,5/8



Molla Universal Long

Universal Long tongs
Pince Universal Long
Long Universalzange
Pinzas Universal Long

Acciaio Inox - St. Steel

	mm	in
903 05 81 MUN	270	10,5/8



Molla pane Cosmos

Cosmos bread tongs
Pince à pain Cosmos
Brotzange Cosmos
Pinzas pan Cosmos

Acciaio Inox/Nylon - St. Steel/ Nylon

	mm	in
V53 05 81 MPA 15 225	225	8,7/8



Molla spaghetti Cosmos

Cosmos spaghetti tongs
Pince à spaghetti Cosmos
Spaghettizzange Cosmos
Pinzas spaghetti Cosmos

Acciaio Inox/Nylon - St. Steel/ Nylon

	mm	in
V53 05 81 MSP 15 230	230	9,1/8



Molla arrosto Cosmos

Cosmos roast tongs
Pince à rôti Cosmos
Braten/Fleischzange Cosmos
Pinzas asado Cosmos

Acciaio Inox/Nylon - St. Steel/ Nylon

	mm	in
V53 05 81 MAR 15 220	220	8,5/8



Molla dolce Cosmos

Cosmos cake tongs
Pince à gâteau Cosmos
Gebäckzange Cosmos
Pinzas postre Cosmos

Acciaio Inox/Nylon - St. Steel/ Nylon

	mm	in
V53 05 81 MDO 15 220	220	8,5/8



Molla ghiaccio Cosmos

Cosmos ice tongs
Pince à glace Cosmos
Eiszange Cosmos
Pinzas hielo Cosmos

Acciaio Inox/Nylon - St. Steel/ Nylon

	mm	in
V53 05 81 MGH 15 214	214	8,3/8



Molla ghiaccio de luxe

De luxe ice tongs
Pince à glaçons de luxe
Eiszange de luxe
Pinzas hielo de luxe

Acciaio Inox - St. Steel

	mm	in
903 06 81 MGD	156	6,1/8



Molla pane Basic

Basic bread tongs
Pince à pain Basic
Basic Brotzange
Pinzas pan Basic

Acciaio Inox - St. Steel

	mm	in
903 06 81 MPA	200	7,7/8



Molla spaghetti Basic

Basic spaghetti tongs
Pince à spaghetti Basic
Basic Spaghettizange
Pinzas spaghetti Basic

Acciaio Inox - St. Steel

	mm	in
903 06 81 MSP	202	7,7/8



Molla dolci Basic

Basic cake tongs
Pince à gâteau Basic
Basic Gebäckzange
Pinzas postre Basic

Acciaio Inox - St. Steel

	mm	in
903 06 81 MDL	189	7,1/2



Molla arrosto Basic

Basic roast tongs
Pince à rôti Basic
Basic Fleisch/Servierzange
Pinzas asado Basic

Acciaio Inox - St. Steel

	mm	in
903 06 81 MAR	210	8,1/4



Molla universale Basic

Basic universal tongs
Pince universelle Basic
Basic Universalzange
Pinzas universales Basic

Acciaio Inox - St. Steel

	mm	in
903 06 81 MUN	235	9,1/4



Forbici insalata Basic

Basic salad tongs (scissors type)
Pince ciseaux à salade Basic
Basic Salatzange
Pinzas ensalada tipo tijeras Basic

Acciaio Inox - St. Steel

	mm	in
903 06 81 FIN	200	7,7/8



Forbici dolci Basic

Basic cake tongs (scissors type)
Pince ciseaux à gâteaux Basic
Basic Scherenzange
Pinzas postre tipo tijeras Basic

Acciaio Inox - St. Steel

	mm	in
903 06 81 FDO	195	7,5/8



Paletta raccoglibriciole

Crumb sweeper
Pelle ramasse-miettes
Krümelsammler
Pala recogemigas

Acciaio Inox 18/10 - St. Steel 18/10

	mm	in
903 05 91 939	160	6,1/4



Forchettone spaghetti

Spaghetti serving fork
Fourchette à servir spaghetti
Spaghettigabel
Tenedor servir spaghetti

Acciaio Inox 18/10 - St. Steel 18/10

	mm	in
903 05 91 792	278	11



Campanello reception

Reception bell
Sonette de réception
Hotelglocke
Timbre recepcìon

Acciaio Inox - St. Steel

AVARI 112



Schiaccianoci forgiato

Nut cracker - forged
Casse noix forgé
Nußknacker geschmieden
Cascanueces forjado

Acciaio Inox - St. Steel

	mm	in
AVARI 117	150	6



Spillone pizzeria

Pizza pin
Épingle pour commandes pizzeria
Pizzeria Stecknadel
Agujón para hojas pedidos pizzeria

Acciaio Inox - St. Steel

AVARI 086



Ciotola black Taste

Small bowl, black, Taste
 Bol petit black Taste
 Bol pequeño black Taste
 Kleine Schüssel, schwarz, Taste

Acciaio Inox/PTFE - Steel/PTFE

	ø cm	H cm	ml
V33 05 43 003	11,25	3	200



Ciotola black Taste

Bowl, black, Steel/PTFE
 Bol black Taste
 Bol black Taste
 Schüssel, schwarz, Taste

Acciaio Inox/PTFE - Steel/PTFE

	ø cm	H. cm	ml
V33 05 43 001	5,9	3	50
V33 05 43 002	7	4	130



Ciotola conica black Taste

Bowl, conical, black, Taste
 Bol conique black Taste
 Bol conico black Taste
 Schüssel konisch, schwarz, Taste

Acciaio Inox/PTFE - Steel/PTFE

	ø cm	H. cm	ml
V33 05 43 004	6,5	3,5	90
V33 05 43 005	8	3,8	130



Bicchieri black acciaio Taste

Tumbler, black, Taste
 Verre black acier Taste
 Vaso black acero Taste
 Vase, schwarz, Taste

Acciaio Inox/PTFE - Steel/PTFE

	ø cm	H. cm	ml
V33 05 43 006	8,5	8,5	400



Pentola 2 maniglie Taste

Pot, 2-handle, Taste

Pot 2 anses Taste

Olla 2 asas Taste

Topf, 2 Griffe, Taste

Rame/Acciaio - Copper/Steel

	ø cm	H. cm	ml
V33 05 72 001	10	5,5	300

Coperchio Taste

Lid, Taste

Couvercle Taste

Tapa Taste

Decker, Taste

Rame/Acciaio - Copper/Steel

	ø cm
V33 05 72 007	10

Casseruola 1 manico Taste

Casserole 1-handle, Taste

Casserole 1 anse Taste

Cacerola 1 asa Taste

Topf, 1 Griff, Taste

Rame/Acciaio - Copper/Steel

	ø cm	H. cm	ml
V33 05 72 006	10	5,5	300

Casseruola 2 maniglie Taste

Casserole 2-handle, Taste

Casserole 2 anses Taste

Cacerola 2 asas cuivre/acero

Kasserolle mit 2 Griffen, Taste

Rame/Acciaio - Copper/Steel

	ø cm	H. cm	ml
V33 05 72 002	11,5	4,5	350
V33 05 72 003	14	5	550

Padella 1 manico Taste

Fryng pan 1-handle, Taste

Poêle 1 anse Taste

Sartén 1 asa Taste

Bratpfanne 1 Griff, Taste

Rame/Acciaio - Copper/Steel

	ø cm	H. cm	ml
V33 05 72 004	14	3,5	400
V33 05 72 005	15,5	4	550

Bistecchiera Taste

Grill pan Taste
Poêle à griller Taste
Sartén para asar Taste
Grillpfanne Taste

Alluminio Pressofuso - Die-cast Aluminium

	cm	H. cm
V33 11 72 001	15,75 × 15,75	2,5



Padella 1 manico, Taste

Frying pan 1-handle, Taste
Poêle 1 anse Taste
Sartén 1 asa Taste
Bratpfanne, 1 Griff, Taste

Alluminio Pressofuso - Die-cast Aluminium

	ø cm	H. cm
V33 11 72 002	12,5	2,5
V33 11 72 003	16,25	3,5



Casseruola 2 maniglie Taste

Casserole 2-handle, Taste
Casserole 2 anses Taste
Cacerola 2 asas cuivre/acero
Kasserolle mit 2 Griffen, Taste

Alluminio Pressofuso - Die-cast Aluminium

	ø cm	H. cm
V33 11 72 004	9,75	4,75



Forchettina appetizer Taste

Appetiser fork, Taste
Fourchette à apéritif, Taste
Tenedor pequeño para aperitivos, Taste
Vorspeisengabel, rund Taste

Acciaio 18/10 - 18/10 St. Steel

	cm
CP2 38 M	8



Cestello fritto tondo Taste

Frying basket, round, Taste
Petit panier à friture rond, Taste
Cestita para freír redonda, Taste
Frittierkorb, rund Taste

Acciaio 18/10 - 18/10 St. Steel

	ø cm	H. cm
V33 05 95 002	9	9,2



Cestello fritto rettangolare Taste

Frying basket, rect. Taste
Panier à friture rect. Taste
Cestita para freír rect. Taste
Frittierkorb, rechteckig Taste

Acciaio 18/10 - 18/10 St. Steel

	cm	H. cm
V33 05 95 001	10,5 × 9	7,5



Ciotola tonda Taste

Small bowl, round, Taste
 Petit bol rond en Taste
 Bol pequeño redondo Taste
 Kleine Schüssel, rund, Taste

Porcellana - Porcelain

	ø cm	Interno/Inside ø cm	H. cm
V87 21 42 006	10	3,5	3

Ciotolina quadrata Taste

Small bowl, square, Taste
 Petit bol carré en Taste
 Bol pequeño cuadrado Taste
 Kleine Schüssel, quadratisch, Taste

Porcellana - Porcelain

	cm	H. cm
V87 21 42 008	8 × 8	2,4

Ciotolina a goccia Taste

Small bowl, drop-shaped, Taste
 Petit bol en forme de goutte en Taste
 Bol pequeño en forma de lágrima Taste
 Kleine Schüssel, Tropfen-förmig, Taste

Porcellana - Porcelain

	cm	H. cm
V87 21 42 001	8 × 7	3,4

Ciotola square Taste

Square bowl, Taste
 Bol Square en Taste
 Bol Square Taste
 Schüssel, quadratisch, Taste

Porcellana - Porcelain

	cm	H. cm
V87 21 42 002	10 × 7,7	3,5

Coppetta tonda Taste

Bowl, round, small, Taste
 Petit bol rond en Taste
 Bol pequeño redondo Taste
 Schüssel, rund, Taste

Porcellana - Porcelain

	ø cm	H. cm
V87 21 42 005	6,5	3,8

Ciotola square Taste

Square bowl, Taste
 Bol Square en Taste
 Bol Square Taste
 Schüssel, quadratisch, Taste

Porcellana - Porcelain

	cm	H. cm
322 21 22 691	9,5 × 9,5	1,2



INSPIRATION

INSPIRATION

INSPIRATIONAL BURGER

Vassoio da banco/bar pasticceria

Bar/pastry tray
Plateau bar/pâtisserie
Konditoreiplatte
Bandeja bar/pastelería

Acciaio inox 18/10 - St. steel 18/10

	cm	H. cm	in	H. in
V01 05 23 P08	35x20 sp	H.0,8	13.3/4x7.7/8	0,31
V01 05 23 P02	60x10 sp	H.0,8	23.5/8x4	0,31

Coltello Angus

Angus steak knife
Couteau à bifteck Angus
Angus Steakmesser
Cuchillo carne Angus

Acciaio Inox - St. Steel / POM

	cm	in
CAN 55	23	9

Forchetta Marea

Marea fork
Fourchette Marea
Marea Gabel
Tenedor Marea

Acciaio Inox 18/10 - St. Steel 18/10

	cm	in
CE4 02	20,4	8

Macinapepe/spargisale

Pepper mill/salt shaker
Moulin à poivre/salière
Pfeffermühle/Pfefferstreuer
Molinillo pimienta/salero

Acrilico + Ceramica + Al / Acrylic + Ceramic + Aluminum

	ø cm	ø in	H. cm	H. in
AVARI 075 A	4x4	1,5/8x1,5/8	12	4,3/4
AVARI 075 B	4x4	1,5/8x1,5/8	9	3,1/2

Macinapepe /
spargisale

Coltello
Angus

Forchetta
Marea



Vassoio da banco/
bar pasticceria



INSPIRATIONAL SUSHI

Piatto refrigerato Celsius-Ice

Celsius-Ice dish, refrigerated
Plat réfrigéré Celsius-Ice
Celsius-Ice Servierplatte, gekühlt
Fuente refrigerada Celsius-Ice

Acciaio inox 18/10 - St. steel 18/10

	ø cm	H. cm	ø in	H. in
CI 22 600R	32	3,5	12,5/8	1,3/8

Bacchette sushi Ergo

Ergo sushi chopsticks
Baguettes à sushi Ergo
Ergo Sushi stäbchen
Palillos para sushi Ergo

Inox 18/10 - St. Steel

	cm	in
903 05 84 660 X	23	9

Set 2 pz - 2-pc set

Poggiabastoncini Ergo

Ergo cutlery stand
Porte - couverts Ergo
Ergo Besteck Bänke
Posa cubiertos Ergo

Inox 18/10 - St. Steel

	cm	in
903 05 84 662	6	2,3/8



**Piatto
refrigerato**



**Poggiabastoncini
Ergo**



**Bacchette
sushi Ergo**

INSPIRATIONAL STEAK



Vassoio grill rettangolare

Vassoio grill rettangolare Celsius

Celsius grill tray, rectangular
Plateau grill rectangulaire Celsius
Celsius grilltablett rechteckig
Bandeja grill rectangular Celsius

Acciaio Inox 18/10 - St. Steel 18/10

Alluminio - Aluminum

Legno di betulla - Birch wood

	cm	in
V89 05 SE 001	29x20	11,1/2x7,7/8

Forchetta carne Ergo

Ergo steak fork
Fourchette à bifteck Ergo
Ergo Steakgabel
Tenedor carne Ergo

Acciaio inox 18/10 - St. Steel 18/10

	cm	in
CE552	20	7,7/8

Coltello carne Safari

Safari steak knife
Couteau à bifteck Safari
Safari Steakmesser
Cuchillo carne Safari

Acciaio + legno - St. Steel + wood

	cm	in
CE5 A5 5LC	23,5	9,1/4



Forchetta carne
Ergo

Coltello carne
Safari

INSPIRATIONAL SEAFOOD



Piatto refrigerato

Piatto refrigerato Celsius-Ice

Celsius-Ice Thermal dish
Plat réfrigéré Celsius-Ice
Celsius-Ice Fuente refrigerada
Servierplatte, gekühlt Celsius-Ice

Acciaio Inox 18/10 - St. Steel 18/10

	ø cm	ø in	H. cm	h in
V330522001	23	9	4,5	1,3/4

Matisse forchetta ostriche

Matisse oyster fork
Fouchette à crustacés Matisse
Tenedor ostras Matisse
Austerngabel Matisse

Acciaio Inox 18/10 - St,Steel 18/10

	cm	in
CF164	15,6	6,1/8



Matise forchetta
ostriche

SHARING HAPPY HOURS

Alzata presentazione corten Domino

Domino podium, corten
Présentoir Domino corten
Domino Podium, corten
Soporte presentación Domino corten

Acciaio Verniciato - Varnished Steel

	cm	H. cm	in	H. in
V331842020	20x40	9	7,7/8x15,3/4	3,1/2

Gres Corten mix

	cm	in
V332142002	20x20	7,7/8x7,7/8

Cornice scura Domino

Domino frame, dark
Cadre foncé Domino
Domino Rahmen, dunkel
Marco oscuro Domino

Legno Massello - Solid Wood

	cm	H. cm	in	H. in
V330442151	20x40	5	7,7/8x15,3/4	2
V330442153	40x40	5	15,3/4x15,3/4	2

Tagliere formaggi color noce Domino

Domino cheese cutting board, walnut colour
Planche à découper fromages couleur noix Domino
Domino Käsebrett, Walnuss
Tabla de cortar quesos color nuez Domino

Legno massello - Solid wood

	cm	H. cm	in	H. in
V330471003	20x40	2	7,7/8x15,3/4	0,3/4

Vaso in vetro con coperchio

Glass jar with lid
Pot en verre avec couvercle
Jarrón de vidrio con tapa
Glasdose mit Deckel

Vetro - Glass

	ø cm	H. cm	ø in	H. in
4041031304	14	17,5	5,1/2	6,7/8



Vaso in vetro
con coperchio

Gres Corten mix



Alzata presentazione
corten Domino

Tagliere formaggi
color noce Domino

Cornice scura
Domino

SHARING SEAFOOD

Piatto refrigerato

Thermal dish
Plat réfrigéré
Fuente refrigerada
Servierplatte, gekühlt

Acciaio Inox 18/10 - St. Steel 18/10

	ø cm	ø in
V33 05 22 001	23	9

Piatto tondo Imperfetto

Imperfetto round plate
Plat rond Imperfetto
Plato redondo Imperfetto
Imperfetto Teller rund

Acciaio Inox 18/10 - St. Steel 18/10

	ø cm	ø in
Z33 28 24 002	36	14,1/8
Z33 28 24 003	42	16,1/2

Supporto in filo per piatto refrigerato

Wire stand for thermal dish
Support en fil d'acier pour plat réfrigéré
Soporte en hilo de acero para fuente redonda
Drahtständer für Thermoplatte

Acciaio Inox 18/10 - St. Steel 18/10

	H base cm	H base in
Z33 80 42 001	28	11

Stiletto aragosta

Lobster pick
Fourchette à homard
Langustegabel
Tenedor langosta

Acciaio Inox 18/10 - St. Steel 18/10

	cm	in
903 05 84 659	20,2	7,7/8

Pinza aragosta forgiata

Lobster cracker, forged
Pince à homard forgé
Langustezange - geschmieden
Pinzas langosta forjadas

Acciaio Inox - St. Steel

	cm	in
305 05 91 658	19	7,1/2

Piattino per finger food

Small dish for finger food
Petit plat pour finger food
Platito para finger food
Schale klein für Fingerfood

Acciaio Inox 18/10 - St. Steel 18/10

	ø cm	ø in
V390521001	9	3,1/2



Pinza e stiletto aragosta

A two-tiered stainless steel serving stand is the central focus. The top tier is a shallow, round stainless steel plate filled with crushed ice and several large, cooked crayfish. The bottom tier is a larger, shallow stainless steel plate also filled with crushed ice, featuring a variety of seafood including crayfish, oysters, and what appears to be a lobster tail. The stand is supported by three thin, vertical stainless steel legs. The entire setup is placed on a dark, reflective glass table. In the foreground, there are other stainless steel serving items: a small round plate on a pedestal and a larger shallow dish. A glass of yellow liquid is partially visible on the left side.

Piatto tondo Imperfetto

Supporto in filo per piatto refrigerato

Piatto refrigerato

Piatto tondo Imperfetto

Piatto refrigerato

Piattino per finger food

SHARING DESSERTS

Alzata pasticceria 1 piano

Petit four stand
Support à pâtisserie
Petits-Fours-Ständer
Presentación pastelería

Acciaio Inox 18/10 - St. Steel 18/10

	ø cm	H. cm	ø in	H. in
V36 05 41 012	12	13	4,3/4	5,1/8
V36 05 41 016	16	13	6,1/4	5,1/8

Alzata pasticceria 2 piani

2-tier petit four stand
Support à pâtisserie à 2 étages
Petits-fours ständer 2-stufig
Presentación pastelería 2 pisos

Acciaio Inox 18/10 - St. Steel 18/10

	ø cm	H. cm	ø in	H. in
V36 05 41 201	16-12	17	6,1/4-4,3/4	6.3/4

Alzata pasticceria 3 piani

3-tier petit four stand
Support à pâtisserie à 3 étages
Kuchenständer 3-stufig
Presentación pastelería 3 pisos

Acciaio Inox 18/10 - St. Steel 18/10

	ø cm	H. cm
	22-16-12	30
	ø in	H. in
V36 05 41 301	8,5/8-6,1/4-4,3/4	11.3/4

Piattino per finger food

Small dish for finger food
Petit plat pour finger food
Platito para finger food
Schale klein für Fingerfood

Acciaio Inox 18/10 - St. Steel 18/10

	ø cm	ø in
V390521001	9	3,1/2

Alzata pasticceria
1 piano



A three-tiered silver cake stand is the central focus, set on a light green table. The top tier holds a single white macaron. The middle tier is filled with several red macarons. The bottom tier features a variety of pastries, including a large white dome-shaped dessert with a blueberry and gold leaf, several colorful macarons (red, yellow, orange, purple), and three small round tarts with different fillings. The background is filled with lush green foliage, and the lighting is bright and natural.

**Alzata pasticceria
3 piani**

**Alzata pasticceria
2 piani**

**Piattino per
finger food**



LIGHTING

LIGHTING



Lampada ricaricabile Tempo Mini bianca

Tempo Mini rechargeable lamp, white
 Lampe rechargeable Tempo Mini blanche
 Lampe, wiederaufladbar, Tempo Mini, weiß
 Lámpara recargable Tempo Mini blanca

Alluminio verniciato - Varnished Aluminum

	ø cm	ø in	H. cm	H. in
910 13 17 005	8,5	3,3/8	22	8,5/8



Lampada ricaricabile Tempo Mini corten

Tempo Mini rechargeable lamp, corten
 Lampe rechargeable Tempo Mini corten
 Lampe, wiederaufladbar, Tempo Mini, corton
 Lámpara recargable Tempo Mini corten

Alluminio verniciato - Varnished Aluminum

	ø cm	ø in	H. cm	H. in
910 55 17 005	8,5	3,3/8	22	8,5/8



Lampada ricaricabile Tempo Mini Mini antracite

Tempo Mini Mini rechargeable lamp, anthracite
 Lampe rechargeable Tempo Mini anthracite
 Lampe, wiederaufladbar, Tempo Mini, anthrazit
 Lámpara recargable Tempo Mini antracita

Alluminio verniciato - Varnished Aluminum

	ø cm	ø in	H. cm	H. in
910 78 17 005	8,5	3,3/8	22	8,5/8



Lampada ricaricabile Tempo mini salvia

Tempo Mini rechargeable lamp, sage green
Lampe rechargeable Tempo Mini, vert sauge
Lampe, wiederaufladbar, Tempo Mini, Salbeigrün
Lámpara recargable Tempo Mini, salvia

Alluminio verniciato - Varnished Aluminum

	ø cm	ø in	H. cm	H. in
910 24 17 005	8,5	3,3/8	22	8,5/8



Lampada ricaricabile Tempo mini sabbia

Tempo Mini rechargeable lamp, sand-colored
Lampe rechargeable Tempo Mini, couleur sable
Lampe, wiederaufladbar, Tempo Mini, sandfarbene
Lámpara recargable Tempo Mini, color arena

Alluminio verniciato - Varnished Aluminum

	ø cm	ø in	H. cm	H. in
910 79 17 005	8,5	3,3/8	22	8,5/8





Lampada ricaricabile Tempo bianca

Tempo rechargeable lamp, white
 Lampe rechargeable Tempo blanche
 Lampe, wiederaufladbar, Tempo, weiß
 Lámpara recargable Tempo blanca

Alluminio verniciato - Varnished Aluminum

	ø cm	ø in	H. cm	H. in
910 13 17 001	10	3,7/8	28	11



Lampada ricaricabile Tempo corten

Tempo rechargeable lamp, corten
 Lampe rechargeable Tempo corten
 Lampe, wiederaufladbar, Tempo, corton
 Lámpara recargable Tempo corten

Alluminio verniciato - Varnished Aluminum

	ø cm	ø in	H. cm	H. in
910 55 17 001	10	3,7/8	28	11



Lampada ricaricabile Tempo antracite

Tempo rechargeable lamp, anthracite
 Lampe rechargeable Tempo anthracite
 Lampe, wiederaufladbar, Tempo, anthrazit
 Lámpara recargable Tempo antracita

Alluminio verniciato - Varnished Aluminum

	ø cm	ø in	H. cm	H. in
910 78 17 001	10	3,7/8	28	11



Lampada ricaricabile Tempo salvia

Tempo rechargeable lamp, sage green
Lampe rechargeable Tempo, vert sauge
Lampe, wiederaufladbar, Tempo, Salbeigrün
Lámpara recargable Tempo, salvia

Alluminio verniciato - Varnished Aluminum

	ø cm	ø in	H. cm	H. in
910 24 17 001	10	3,7/8	28	11



Lampada ricaricabile Tempo sabbia

Tempo rechargeable lamp, sand-colored
Lampe rechargeable Tempo, couleur sable
Lampe, wiederaufladbar, Tempo, sandfarbene
Lámpara recargable Tempo, color arena

Alluminio verniciato - Varnished Aluminum

	ø cm	ø in	H. cm	H. in
910 79 17 001	10	3,7/8	28	11

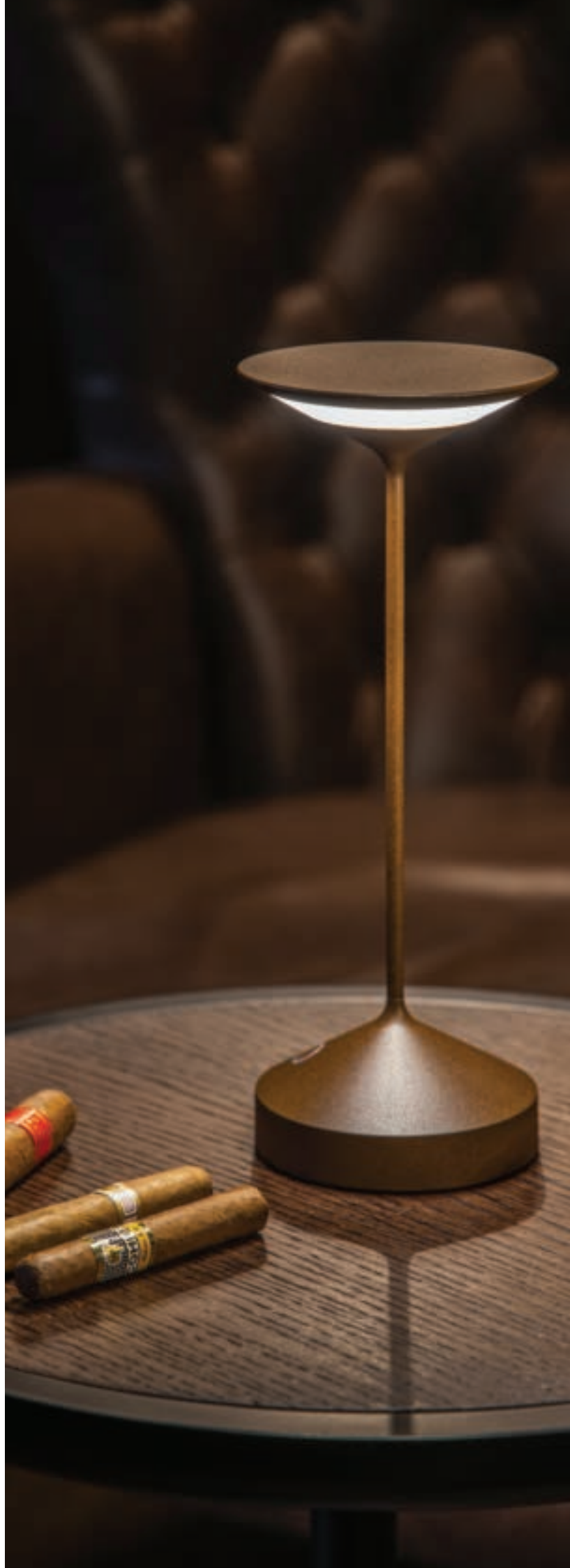





Lampada Saturno bianca

Saturno rechargeable lamp, white
 Lampe rechargeable Saturno blanche
 Lampe, wiederaufladbar, Saturno, weiß
 Lámpara recargable Saturno blanca

Alluminio verniciato - Varnished Aluminum

	ø cm	ø in	H. cm	H. in
910 13 17 006	9,5	3,3/4	30	11,3/4



Lampada Saturno nera

Saturno rechargeable lamp, black
 Lampe rechargeable Saturno noire
 Lampe, wiederaufladbar, Saturno, schwarz
 Lámpara recargable Saturno oscuro

Alluminio verniciato - Varnished Aluminum

	ø cm	ø in	H. cm	H. in
910 15 17 006	9,5	3,3/4	30	11,3/4



Lampada ricaricabile personalizzabile Logo

Logo customizable rechargeable lamp
 Lampe rechargeable personnalisable Logo
 Lampe, wiederaufladbar, personalisiertes Logo
 Lámpara recargable personalizable Logo

**Alluminio verniciato - Varnished Aluminum /
 Policarbonato - polycarbonate**

	ø cm	ø in	H. cm	H. in
910 13 17 004	12	4,3/4	37,5	14,3/4





A
Dima di plastica
Plastic template

B
Fascia opacizzante con texture
Fabric neutral decorative band



C
Cilindro superiore trasparente
Top transparent cylinder

D
Cilindro inferiore luminoso
Bright bottom cylinder

Illuminare è arredare: la giusta illuminazione è importante dal punto di vista estetico e funzionale per la valorizzazione degli spazi.

La lampada LOGO è personalizzabile e questo ti consente di valorizzare il tuo stile e la tua personalità in tutti gli ambienti.

Nella confezione di LOGO è contenuta una dima di plastica trasparente (A) per poter ritagliare stoffe o carta (stampabile su un formato A3) da inserire sotto la calotta di plastica della fonte luminosa, permettendone così la personalizzazione.

La confezione comprende anche una fascia decorativa neutra (B) in uno speciale tessuto (pre-inserito) della dimensione corretta (stessa dimensione della dima di plastica). Questa fascia, inserita a contatto con la lampada, prima della carta opportunamente ritagliata (E), conferirà matericità ed eleganza a qualunque materiale vorrete usare per la personalizzazione.

Lighting is furnishing: the right lights are important from the aesthetic and functional point of view in order to enhance spaces. The lamp LOGO is customizable, and that allows you to make the most of your style and your personality in all the environments.

LOGO comes with a clear plastic template (A), in order to cut fabric or paper (printable on A3) to be inserted under the plastic cover of the light source, thus allowing customization.

The package includes a special fabric neutral decorative band (B) (previously placed) whose dimension is correct (same dimensions as the plastic template). Such band, in contact with the lamp, before your paper appropriately cut (E), gives material consistency and elegance to any material you will want to use for customization.

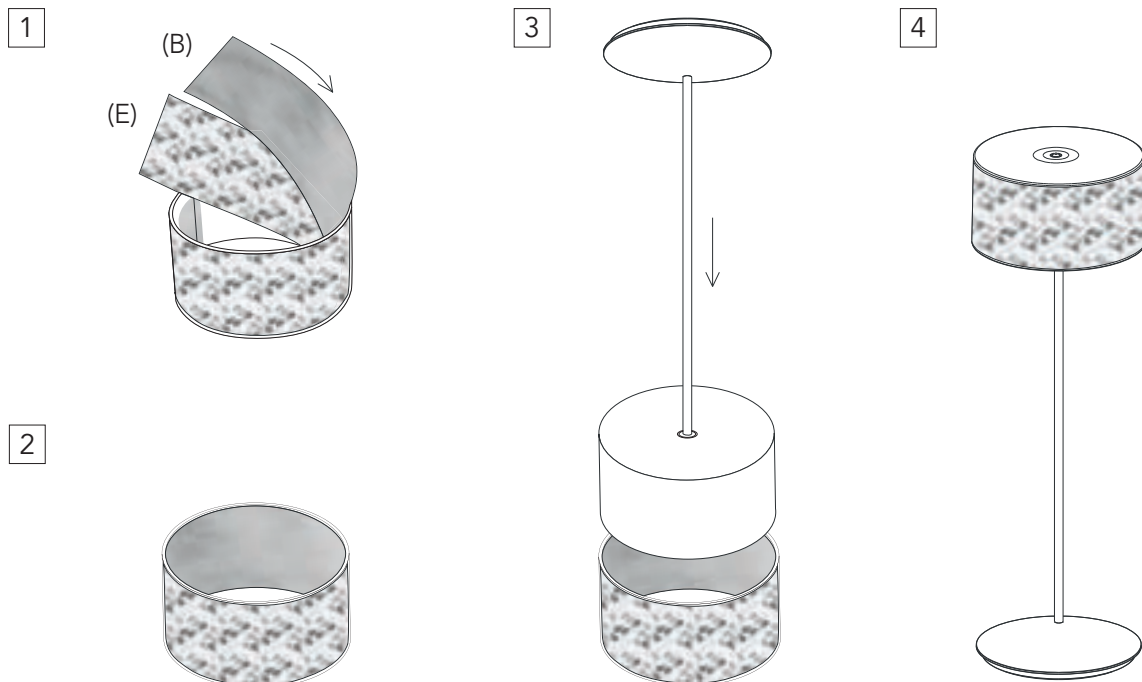





Lampada ricaricabile Resort bianca

Resort rechargeable lamp, white
 Lampe rechargeable Resort blanche
 Lampe, wiederaufladbar, Resort, weiß
 Lámpara recargable Resort blanca

Alluminio verniciato - Varnished Aluminum

	LxP cm	LxP in	H. cm	H. in
910 13 17 002	10x10	4x4	34	13,3/4



Lampada ricaricabile Resort corten

Resort rechargeable lamp, corten
 Lampe rechargeable Resort corten
 Lampe, wiederaufladbar, Resort, corton
 Lámpara recargable Resort corten

Alluminio verniciato - Varnished Aluminum

	LxP cm	LxP in	H. cm	H. in
910 55 17 002	10x10	4x4	34	13,3/4



Lampada ricaricabile Resort antracite

Resort rechargeable lamp, anthracite
 Lampe rechargeable Resort anthracite
 Lampe, wiederaufladbar, Resort, anthrazit
 Lámpara recargable Resort antracita

Alluminio verniciato - Varnished Aluminum

	LxP cm	LxP in	H. cm	H. in
910 78 17 002	10x10	4x4	34	13,3/4







Lampada ricaricabile Resort Maxi bianca

Resort Maxi rechargeable lamp, white
 Lampe rechargeable Resort Maxi blanche
 Lampe, wiederaufladbar, Resort Maxi, weiß
 Lámpara recargable Resort Maxi blanca

Alluminio verniciato - Varnished Aluminum

	LxP cm	LxP in	H. cm	H. in
910 13 17 003	14x14	5,1/2x5,1/2	54	21,1/4



Lampada ricaricabile Resort Maxi corten

Resort Maxi rechargeable lamp, corten
 Lampe rechargeable Resort Maxi corten
 Lampe, wiederaufladbar, Resort Maxi, corton
 Lámpara recargable Resort Maxi corten

Alluminio verniciato - Varnished Aluminum

	LxP cm	LxP in	H. cm	H. in
910 55 17 003	14x14	5,1/2x5,1/2	54	21,1/4



Lampada ricaricabile Resort Maxi antracite

Resort Maxi rechargeable lamp, anthracite
 Lampe rechargeable Resort Maxi anthracite
 Lampe, wiederaufladbar, Resort Maxi, anthrazit
 Lámpara recargable Resort Maxi antracita

Alluminio verniciato - Varnished Aluminum

	LxP cm	LxP in	H. cm	H. in
910 78 17 003	14x14	5,1/2x5,1/2	54	21,1/4

Lampada a batterie ricaricabile (tramite base di ricarica e caricatore inclusi). È una lampada di grande qualità, costruita con materiali nobili e inalterabili: alluminio pressofuso e alluminio estruso. Verniciata con polveri epossidiche termoindurenti.

Rechargeable battery lamp (charging base and charger are included). It is a high-quality lamp, made of durable and noble materials: die-cast aluminum and extruded aluminum. It is thermosetting epoxy powder coated.



Misure / Dimensions	Base Ø12, H 37cm	Base ø 10cm, H 28cm	Base ø 8,5 H 22 cm
Colori disponibili Available colours	Bianco White	Bianco, corten, antracite White, corten, anthracite	Antracite, bianco White, anthracite
Dimmerabilità Dimmability	La lampada è dotata di un interruttore a contatto che consente l'accensione, lo spegnimento e la variabilità della potenza luminosa. The lamp is provided with a contact on/off switch, which allows to change the light intensity as well.		
Potenza / Wattage	2,2 watt	2,5 watt	1,5 watt
Volt	3,7 (DC, corrente continua) / 3,7 (DC, direct current)		
Flusso luminoso reale Actual luminous flux	230 lumen	200 lumen	150 lumen
Batteria Battery	9109917004 Litio, 1 batteria da 3800mA Lithium, 1 battery, 3800 mA/h	9109917001 Litio, 2 batterie da 2200 mA/h cad Lithium, 2 batteries, 2200 mA/h each	Litio, batteria da 1600 mA/h Lithium, 1 battery, 1600 mA/h
Tempo di ricarica Charging time	da 6 a 8 ore from 6 to 8 hours	da 6 a 8 ore from 6 to 8 hours	da 6 a 7 ore from 6 to 7 hours
Autonomia / Autonomy	circa 9 ore / 9 hours approximately	circa 10 ore / 10 hours approximately	circa 10 ore / 10 hours approximately

Protezione contro gli agenti atmosferici

Protection against natural elements

Protezione contro polvere e pioggia (IP54).

Il caricatore e la base di ricarica non sono protetti dalla pioggia e vanno utilizzati solo all'interno.

Protection against dust and rain (IP54). The charging base is not protected against rain and should therefore only be used indoors.

La lampada è costruita da materiali riciclabili (alluminio, acciaio, tecnopolimero)

The lamp is made of recyclable materials (aluminum, steel, technopolymer)

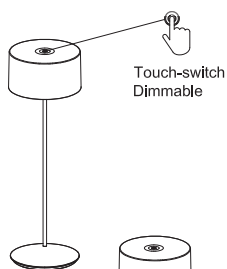

Touch-switch Dimmable



CAVO DI RICARICA PER LOGO
CHARGING CABLE FOR LOGO

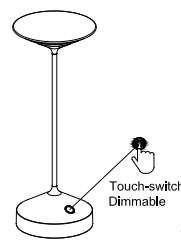

Touch-switch Dimmable



BASE DI RICARICA
CHARGING BASE

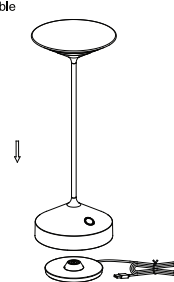
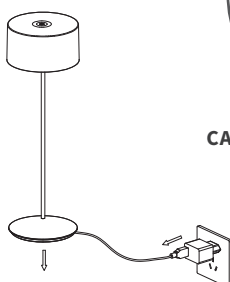

Lampada a batterie ricaricabile (tramite base di ricarica e caricatore inclusi). È una lampada di grande qualità, costruita con materiali nobili e inalterabili: alluminio pressofuso e alluminio estruso. Verniciata con polveri epossidiche termoindurenti.

Rechargeable battery lamp (charging base and charger are included). It is a high-quality lamp, made of durable and noble materials: die-cast aluminum and extruded aluminum. It is thermosetting epoxy powder coated.



Base 10 x 10cm, H 34cm	Base 14 x 14cm, H 54cm	Base ø 9,5 cm, H 30cm
Bianco, corten, antracite White, corten, anthracite	Bianco, corten, antracite White, corten, anthracite	Bianco, nero White, black
La lampada è dotata di un interruttore a contatto che consente l'accensione, lo spegnimento, la variabilità della potenza luminosa e della temperatura della luce (calda/fredda, solo per modello Saturno). The lamp is provided with a contact on/off switch, which allows to change the light intensity and the light temperatures as well (warm/cold, only for Saturno lamp).		
2,2 watt	2,2 watt	2,2 watt
3,7 (DC, corrente continua) / 3,7 (DC, direct current)		5
180 lumen	180 lumen	158 lumen/2700K - luce fredda/cold light 167 lumen/3000K - luce calda/warm light
9109917001 Litio, 2 batterie da 2200 mA/h cadauna Lithium, 2 batteries, 2200 mA/h each	9109917001 Litio, 2 batterie da 2200 mA/h cadauna Lithium, 2 batteries, 2200 mA/h each	9109917001 Litio, 2 batterie da 2200 mA/h cadauna Lithium, 2 batteries, 2200 mA/h each
da 6 a 8 ore from 6 to 8 hours	da 6 a 8 ore from 6 to 8 hours	da 5 a 6 ore from 5 to 6 hours
circa 12 ore / 12 hours approximately	circa 12 ore / 12 hours approximately	circa 12 ore / 12 hours approximately

Protezione contro polvere e pioggia (IP54).

Il caricatore e la base di ricarica non sono protetti dalla pioggia e vanno utilizzati solo all'interno.

Protection against dust and rain (IP54). The charging base is not protected against rain and should therefore only be used indoors.

La lampada è costruita da materiali riciclabili (alluminio, acciaio, tecnopolimero)

The lamp is made of recyclable materials (aluminum, steel, technopolymer)





Multipresa 12 USB

USB multisolet, 12-position
 Multiprise USB à 12 positions
 Multienchufe USB de 12 posiciones
 USB-Mehrfachsteckdose, 12-polig

411 99 81 503



Base lampade Tempo/Resort/Saturno 12 pos. senza multipresa

Tempo/Resort/Saturno lamp base 12 pos. w/out multisolet
 Base de lampe Tempo/Resort/Saturno 12 pos. sans multiprise
 Base lampara Tempo/Resort/Saturno 12 pos. sin multienchufe
 Tempo/Resort/Saturno Lampensockel, 12 Pos. ohne Mehrfachsteckdose

	LxP cm	LxP in	H. cm	H. in
910 04 23 002	66 x 48	26 x 19	5	2



Base Logo 12 pos. senza multipresa

Logo lamp base 12 pos. w/out multisolet
 Base de lampe Logo 12 pos. sans multiprise
 Base lampara Logo 12 pos. sin multienchufe
 Logo Lampensockel, 12 Pos. ohne Mehrfachsteckdose

	LxP cm	LxP in	H. cm	H. in
910 04 23 003	66 x 48	26 x 19	5	2



Set 4pz distanziale per base lampade, acciaio

Spacer set 4-pc for lamp base Steel

Jeu d'entretoises 4 pcs pour base de lampe Acier

Set distanciadores 4 pzs para base lámpara Acero

Distanzstück-Set 4-teilig für Lampensockel Stahl

	cm	in
Z01 37 23 S04	44	17,3/8



Base lampade Tempo/Resort/Saturno 6 pos.

Tempo/Resort/Saturno lamp base 6 pos.

Base de lampe Tempo/Resort/Saturno 6 pos.

Base lámpara Tempo/Resort/Saturno 6 pos.

Tempo/Resort/Saturno Lampensockel, 6 Pos.

Inclusi 4 distanziali / Spacer set 4-pc included

	LxP cm	LxP in	H. cm	H. in
910 04 23 006	53 x 33	20,7/8 x 13	56	22

TAVOLA
NOVO
LLA

TAVOLA



Centrotavola Imperfetto

Imperfetto centrepiece

Centre de table Imperfetto

Imperfetto, Tisch-Centerpiece

Centro de mesa Imperfetto

Inox 18/10 - St.Steel / Legno Massello - Solid Wood

	ø cm	H base cm	ø in	H base in
V333224001	31	4	12,1/4	1,5/8
V333224002	36	4	14,1/8	1,5/8
V333224003	42	4	16,1/2	1,5/8

**Centrotavola Imperfetto**

Imperfetto centrepiece

Centre de table Imperfetto

Imperfetto, Tisch-Centerpiece

Centro de mesa Imperfetto

Inox 18/10 - St.Steel / Legno Massello - Solid Wood

	ø cm	H base cm	ø in	H base in
V333224004	31	7	12,1/4	2,3/4
V333224005	36	7	14,1/8	2,3/4
V333224006	42	7	16,1/2	2,3/4





Alzata set crudité refrigerata

Crudité thermal stand
Plat à crudité réfrigéré
Soporte crudité refrigerada
Thermo-Meeressfrüchtestander

Acciaio Inox 18/10 - St. Steel 18/10

	ø cm	ø in	H base cm	H base in
V33 05 42 002	41	16,1/8	31	12,1/4

Contiene / Contains:

1



Piatto refrigerato Celsius-Ice

Celsius-Ice Thermal dish
Plat réfrigéré Celsius-Ice
Celsius-Ice Fuente refrigerada
Servierplatte, gekühlt Celsius-Ice

Acciaio Inox 18/10 - St. Steel 18/10

	ø cm	ø in	H. cm	H. in
②⑤ V33 05 22 001 23		9	4,5	1,3/4

2



3



Supporto in filo per piatto refrigerato

Wire stand for thermal dish
Support en fil d'acier pour plat réfrigéré
Soporte en hilo de acero para fuente redonda
Drahtständer für Thermoplatte

Acciaio Inox 18/10 - St. Steel 18/10

	H base cm	H base in
③ Z33 80 42 001	28	11

4



Piatto fondo tondo crudité

Crudité platter, deep, round
Assiette à crudités creuse ronde
Plato hondo redondo crudités
Aufschnittplatte, tief, rund

Acciaio Inox 18/10 - St. Steel 18/10

	ø cm	ø in
① Z33 28 42 T01	34	11,5/8
④ Z33 28 42 T02	41	16,1/8

5





Piatto tondo Imperfetto

Imperfetto round plate

Plat rond Imperfetto

Plato redondo Imperfetto

Imperfetto Teller rund

Acciaio Inox 18/10 - St. Steel 18/10

	ø cm	ø in
Z33 28 24 001	31	12,1/4
Z33 28 24 002	36	14,1/8
Z33 28 24 003	42	16,1/2

Celsius

IDEALE PER SERVIRE
PERFECT TO SERVE



CARNE
MEAT



PESCE
FISH



VERDURE
VEGETABLES



PIZZA E NON SOLO
PIZZA & MORE

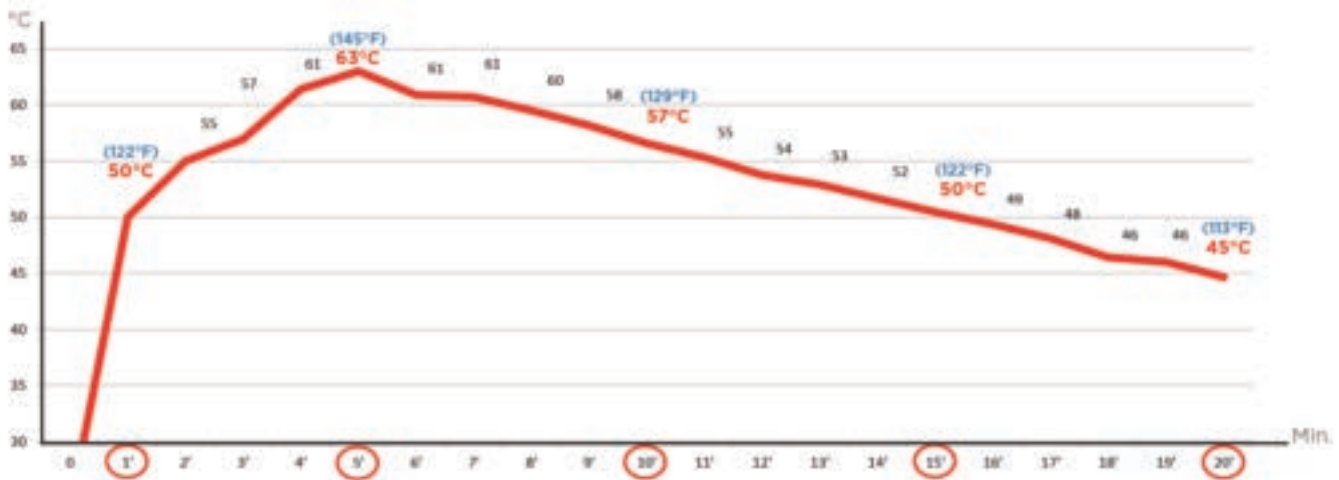

Celsius è il nuovo piatto che mantiene costante la temperatura delle pietanze senza continuare il processo di cottura, per conservare al meglio il gusto di ogni ricetta.

Design moderno ed essenziale, che si abbina a ogni mise en place e innovativa funzionalità grazie alla presa ergonomica della base in legno, che protegge dalle scottature.

La piastra in alluminio viene **riscaldata in forno**, regolando temperatura e tempo a seconda della pietanza, per poi essere posizionata sotto il piatto in acciaio che, a contatto con gli alimenti, **mantiene costante la temperatura** del cibo durante il pasto.

Celsius è un prodotto **igienico e di facile pulizia**: il piatto in acciaio (unica componente a contatto con gli alimenti) è comodamente lavabile in lavastoviglie, a differenza delle pietre ollari che assorbono i grassi, non sono lavabili e alterano lo stato di cottura delle pietanze.

Celsius è disponibile in quattro versioni per rispondere a ogni esigenza, dal singolo posto tavola ai momenti di convivialità, e in due forme adatte a diverse tipologie di pietanze come ad esempio le carni e la pizza.

Celsius. Per non servire più cibi freddi!

Celsius is the new plate that keeps food temperature constant without continuing the cooking process, to best preserve the taste of every recipe.

Modern and essential design, matching with every place setting, and innovative functionality, thanks to the ergonomic grip, and the wood base, that protects from burning.

The aluminum plate is **warmed into the oven**, adjusting temperature and time based on the food; then it is placed under the steel plate that, in contact with food, **keeps its temperature constant** during the meal.

Celsius is a healthy product and **easy to clean**: the steel plate (the only component in contact with food) is dishwasher safe while, for instance, soapstone, that absorbs fat, is not washable and alters food cooking.

Celsius comes in four versions to meet every need, from the individual place setting to the large gatherings, and in two different shapes, suitable for different foods, like meat and pizza.

Celsius. You will not serve cold food anymore!



Vassoio grill rettangolare Celsius

Celsius rectangular grill tray
 Plateau grill rectangulaire Celsius
 Celsius Grilltablett rechteckig
 Bandeja grill rectangular Celsius

	cm	in
V89 05 SE 001	29x20	11,1/2x7,7/8
V89 05 SE 002	34x24	13,3/8x9,1/2

Piatto

Plate
 Plat
 Edelstahl Tablett rechteckig
 Plato

Acciaio Inox 18/10 - St. Steel 18/10

	cm	in
Z89 14 22 R01	25x18,5	9,7/8x7,1/4
Z89 14 22 R02	29,5x21,5	11,5/8x8,1/2

Piastra alluminio

Aluminum plate
 Plaque aluminium
 Aluminiumplatte
 Placa aluminium

Alluminio - Aluminum

	cm	in
Z89 15 22 R01	19x12	7,1/2x4,3/4
Z89 15 22 R02	24x15,5	9,1/2x6,1/8

Base rettangolare

Rectangular base
 Base rectangulaire
 Holzgestell rechteckig
 Base rectangular

Legno di betulla - Birch wood

	cm	in
Z89 19 22 R01	29x20	11,1/2x7,7/8
Z89 19 22 R02	34x24	13,3/8x9,1/2





Vassoio grill ovale Celsius

Celsius oval grill tray
 Plateau grill oval Celsius
 Celsius Grilltablett oval
 Bandeja grill oval Celsius

	cm	in
V89 05 SE 003	28x32	1x12,5/8
V89 05 SE 004	38x34	15x13,3/8

Piatto

Plate
 Plat
 Edelstahl Tablett oval
 Plato

Acciaio Inox 18/10 - St. Steel 18/10

	ø cm	ø in
Z89 14 22 T01	25,5	10
Z89 14 22 T02	31,5	12,3/8

Piastra alluminio

Aluminum plate
 Plaque aluminium
 Aluminiumplatte
 Placa aluminium

Alluminio - Aluminum

	ø cm	ø in
Z89 15 22 T01	20	7,7/8
Z89 15 22 T02	24	9,1/2

Base ovale

Oval base
 Base ovale
 Holzgestell oval
 Base oval

Legno di betulla - Birch wood

	cm	in
Z89 19 22 T01	28x32	1x12,5/8
Z89 19 22 T02	38x34	15x13,3/8





Piatto refrigerato Celsius-Ice

Celsius-Ice thermal dish

Plat réfrigéré Celsius-Ice

Celsius-Ice Servierplatte, gekühlt

Fuente refrigerada Celsius-Ice

Acciaio inox 18/10 - St. steel 18/10

	ø cm	H. cm	ø in	H. in
CI 22 600R	32	3,5	12,5/8	1,3/8

Andamento Temperatura

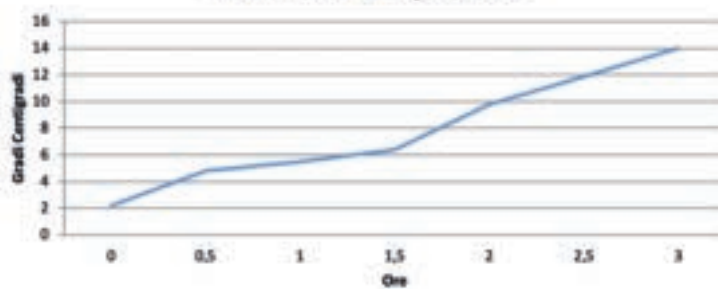





Alzata piccola pasticceria verticale 8 posizioni

Upright small pastry stand 8 positions
Support vertical pour petites pâtisseries 8 positions
Stehender kleiner Gebäckständer 8 Positionen
Soporte vertical para pastelería pequeña 8 posiciones

Inox 18/10 - St. Steel

	ø cm	ø in	H. cm	H. in
V36 05 41 001	12,5	5	30	11 ¾



Alzata piccola pasticceria verticale 4 posizioni

Upright small pastry stand 4 positions
Support vertical pour petites pâtisseries 4 positions
Stehender kleiner Gebäckständer 4 Positionen
Soporte vertical para pastelería pequeña 4 posiciones

Inox 18/10 - St. Steel

	ø cm	ø in	H. cm	H. in
V36 05 41 002	12,5	5	18	7

Portagrissini Tegola

Tegola breadstick holder
 Porte-gressins Tegola
 Tegola Contenedor palitos de pan
 Grissini-Korb Tegola

Acciaio Inox 18/10 - St. Steel 18/10

	cm	in
V39 05 42 003	24x7,5	9,45x3

**Portagrissini/pane Tegola**

Tegola bread basket
 Corbeille à pain Tegola
 Tegola Cesta pan
 Brotkorb Tegola

Acciaio Inox 18/10 - St. Steel 18/10

	cm	in
V39 05 42 001	24x16	9,45x6,3

**Portafrutta Tegola**

Tegola fruit bowl
 Plat à fruits Tegola
 Tegola Plato para fruta
 Obstschale Tegola

Acciaio Inox 18/10 - St. Steel 18/10

	cm	in
V39 05 42 002	27x27	10,5/8x10,5/8







Cestino pane e frutta Cacao con manico in pelle

Cacao bread and fruit basket - with leather handle
 Corbeille à pain et fruits Cacao - avec anses en cuir
 Cacao Brotkorb und Fruchtkakao - mit Ledergriff
 Cesto de pan y fruta Cacao - con asas de piel

Acciaio Inox 18/10 - St. Steel 18/10 + E.P. - E.L.

	cm	in
V05 05 24 M18	18x18	7x7
V05 05 24 M23	23x23	9x9

**Secchio cacao con manico in ecopelle**

Cacao bucket with leather handle
 Seau Cacao avec manche en cuir
 Champagnekühler mit Eimer Cacao (Griff aus Leder)
 Cubo Cacao con mango de cuero

Acciaio Inox 18/10 - St. Steel 18/10 + E.P. - E.L.

	ø cm	H. cm	ø in	H. in
V36 05 20 M01	19	19,5	7,1/2	7,5/8



Cestino pane rettangolare Square

Bread basket Square, rectangular
 Corbeille à pain rectangulaire Square
 Brotkorb Square, rechteckig
 Cesta pan rectangular Square

Acciaio Inox 18/10 - St. Steel 18/10
Cotone - Cotton

	cm	in
V76 05 24 002	20x12	7,7/8x4,3/4

**Cestino pane rettangolare Square**

Bread basket Square, rectangular
 Corbeille à pain rectangulaire Square
 Brotkorb Square, rechteckig
 Cesta pan rectangular Square

Acciaio Inox 18/10 - St. Steel 18/10
Cotone - Cotton

	cm	in
V76 05 24 003	27x12	10,5/8x4,3/4

**Cestino pane Gourmet**

Gourmet bread basket
 Corbeille à pain Gourmet
 Gourmet Brotkorb
 Cesta pan Gourmet
 Cestino pane Gourmet

Acciaio Inox 18/10 - St. Steel 18/10

	cm	in
305 05 24 613	25x15	9,7/8x5,7/8



Cestino pane liscio Majorca

Mallorca bread basket, plain
 Corbeille à pain Mallorca
 Brotkorb Mallorca
 Cesta pan Mallorca lisa

Acciaio Inox 18/10 - St. Steel 18/10

	cm	in
V05 05 24 L18	18,5x18,5	7,1/4 x7,1/4
V05 05 24 L23	23x23	9x9

**Cestino pane ovale**

Bread basket, oval
 Corbeille à pain ovale
 Brotkorb, oval
 Cesta pan oval

Acciaio Inox 18/10 - St. Steel 18/10

	cm	in
V01 05 24 028	28x15	11x6

**Cestino in filo agrumi**

Citrus-fruit basket
 Corbeille à agrumes
 Obstkorb Edelstahl Draht für Zitrusfrüchte
 Cesta cítricos

Acciaio Inox 18/10 - St. Steel 18/10

	ø cm	H. cm	ø in	H. in
906 05 001	21 cm	20	8,1/4	7,7/8



CESTINI PANE IN COTONE

cuscino con noccioli di ciliegia, **riscaldabile**. I cestini sono confezionati in pratici cavallotti a blister su cui sono stampate tutte le informazioni, comprese quelle di utilizzo e lavaggio.

COTTON BREAD BASKET

*cushion with cherry stones, **heatable**. The bread baskets come in practical hangable packs with all the information, including use and washing instructions.*



made in Italy
made in Italy



**Cestino pane**

Bread basket
Corbeille à pain
Brotkorb
Cesta pan

Cotone - Cotton

	cm	H. cm	in	H. in
■ AVARI 161B	11x11	15	4,3/8x 4,3/8	5,7/8
■ AVARI 163B	18x18	18	7,1/8x7,1/8	7,1/8

**Cestino pane**

Bread basket
Corbeille à pain
Brotkorb
Cesta pan

Cotone - Cotton

	cm	H. cm	in	H. in
■ AVARI 162B	11x11	15	4,3/8x 4,3/8	5,7/8
■ AVARI 164B	18x18	18	7,1/8x7,1/8	7,1/8

**Cuscino termico con noccioli**

Thermal cushion
Coussin chauffant
Wärmekissen
Cojìn térmico

Cotone - Cotton

	cm	in
■ 325 05 24 579	11x11	4,3/8x 4,3/8
■ 325 05 24 580	18x18	7,1/8x7,1/8

Cestino pane

Bread basket
Corbeille à pain
Brotkorb
Cesta pan

Cotone - Cotton

	cm	H. cm	in	H. in
■ AVARI 200	14x14	8	5,1/2x5,1/2	3,1/8



Cestino pane

Bread basket
Corbeille à pain
Brotkorb
Cesta pan

Cotone / Cotton

	cm	H. cm	in	H. in
■ AVARI 201	14x14	8	5,1/2x5,1/2	3,1/8



Cestino pane

Bread basket
Corbeille à pain
Brotkorb
Cesta pan

Juta-cotone / Juta-cotton

	cm	H. cm	in	H. in
■ AVARI 202	14x14	8	5,1/2x5,1/2	3,1/8
■ AVARI 205	19x19	10	7,1/2x7,1/2	3,7/8



Cestino portabustine mignon

Tea/sugar bag basket, small
Corbeille à sachets de thé/sucre petite
Klein Stoffkorb, Tee und Zuckerbeutelbehälter
Cestita para bolsitas de té/ azúcar pequeña

Cotone / Cotton

	cm	H. cm	in	H. in
■ AVARI 208	6x8	6	2,3/8x3,1/8	2,3/8
■ AVARI 209	6x8	6	2,3/8x3,1/8	2,3/8

Juta / Juta

■ AVARI 210	6x8	6	2,3/8x3,1/8	2,3/8
-------------	-----	---	-------------	-------



Tovaglietta - grigio/tortora

Placemat, grey/taupe
 Nappe individuelle, gris/taupe
 Mantel individual gris/gris topo
 Klein Tischtuch grau/taubegrau

70% Pvc - 30% Pet

	cm	in
AVARI TO 64	45x30	17,3/4x11,3/4

**Tovaglietta - marrone/oro**

Placemat - brown/gold
 Nappe individuelle marron/or
 Mantel individual gris/oro
 Klein Tischtuch Grau/Gold

70% Pvc - 30% Pet

	cm	in
AVARI TO 65	45x30	17,3/4x11,3/4

**Tovaglietta - marrone lucido**

Placemat - shiny brown
 Nappe individuelle marron brillant
 Mantel individual marrón brillante
 Klein Tischtuch glänzendes Braun

70% Pvc - 30% Pet

	cm	in
AVARI TO 66	45x30	17,3/4x11,3/4

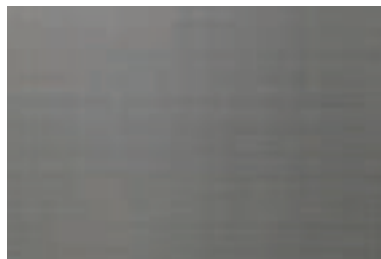
**Tovaglietta intrecciata nera**

Placemat, woven black
 Nappe individuelle tressée noire
 Mantel individual trenzado negro
 Tischset schwarz gewebt

70% Pvc - 30% Pet

	cm	in
AVARI TO 61	45x30	17,3/4x11,3/4

**Tovaglietta intrecciata grigia**

Placemat, woven grey
 Nappe individuelle tressée grise
 Mantel individual trenzado gris
 Tischset grau gewebt

70% Pvc - 30% Pet

	cm	in
AVARI TO 60	45x30	17,3/4x11,3/4

**Tovaglietta intrecciata beige**

Placemat, woven sand
 Nappe individuelle tressée beige
 Mantel individual trenzado beige
 Tischset sand gewebt

70% Pvc - 30% Pet

	cm	in
AVARI TO 63	45x30	17,3/4x11,3/4



Tovaglietta intrecciata marrone

Placemat, woven brown
 Nappe individuelle tressée marron
 Mantel individual trenzado marrón
 Tischset braun gewebt

70% Pvc - 30% Pet

	cm	in
AVARI TO 62	45x30	17,3/4x11,3/4

**Tovaglietta marrone con rettangolo**

Placemat, brown with rectangle
 Nappe individuelle marron avec rectangle
 Mantel individual marrón con rectángulo
 Tischset braun mit Rechteck

70% Pvc - 30% Pet

	cm	in
AVARITO 10	45x30	17,3/4x11,3/4

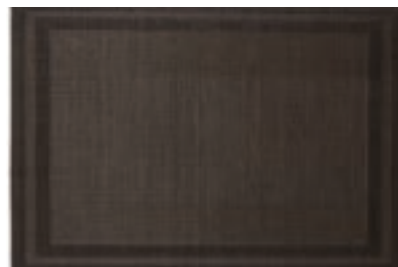
**Tovaglietta riquadri**

Placemat squares
 Nappe individuelle carrés
 Klein Tischtuch mit Quadrat
 Mantel individual cuadrados

70% Pvc - 30% Pet

	cm	in
AVARI TO 50	45x30	17,3/4x11,3/4

**Tovaglietta sabbia/tortora a quadri**

Placemat, sand/taupe with squares
 Nappe individuelle sable/taupe avec carrés
 Mantel individual arena/gris topo de cuadrados
 Tischset sand/Taube mit Quadraten

70% Pvc - 30% Pet

	cm	in
AVARITO 11	45x30	17,3/4x11,3/4

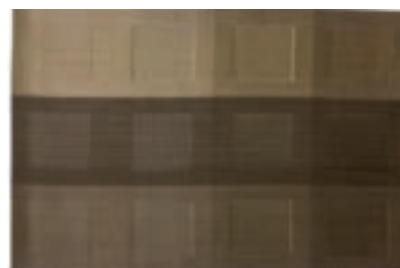
**Tovaglietta marrone 2 fasce laterali**

Placemat, brown with 2 side stripes
 Nappe individuelle marron avec 2 bandes laterales
 Mantel individual marrón con 2 bandas laterales
 Tischset braun mit 2 Seitenstreifen

70% Pvc - 30% Pet

	cm	in
AVARITO 14	45x30	17,3/4x11,3/4

**Tovaglietta sabbia 2 fasce laterali**

Placemat, sand with 2 side stripes
 Nappe individuelle sable avec 2 bandes laterales
 Mantel individual arena con 2 bandas laterales
 Tischset sand mit 2 Seitenstreifen

70% Pvc - 30% Pet

	cm	in
AVARITO 13	45x30	17,3/4x11,3/4



Tovaglietta - grigio scuro

Placemat - dark grey
 Nappe individuelle gris fouché
 Klein Tischtuch dunkel grau
 Mantel individual gris oscuro

70% Pvc - 30% Pet

	cm	in
AVARITO 01	45x30	17,3/4x11,3/4

**Tovaglietta - grigio chiaro**

Placemat- light grey
 Nappe individuelle gris clair
 Klein Tischtuch hellgrau
 Mantel individual gris claro

70% Pvc - 30% Pet

	cm	in
AVARITO 02	45x30	17,3/4x11,3/4

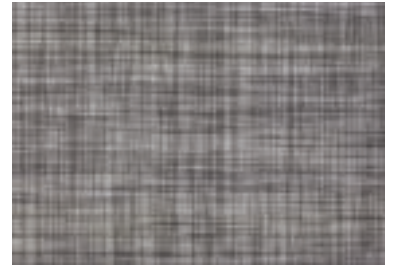
**Tovaglietta - tortora**

Placemat - taupe
 Nappe individuelle taupe
 Klein Tischtuch grau
 Mantel individual gris topo

70% Pvc - 30% Pet

	cm	in
AVARITO 03	45x30	17,3/4x11,3/4

**Tovaglietta beige/marrone/riga azzurra**

Placemat, beige/brown/blue stripe
 Nappe individuelle beige/bleue/marron
 Klein Tischtuch beige/hellblau/braun
 Mantel individual beige/azul claro/marrón

70% Pvc - 30% Pet

	cm	in
AVARITO 05	45x30	17,3/4x11,3/4

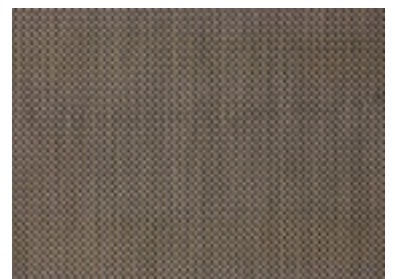
**Tovaglietta - sabbia**

Placemat - sand
 Nappe individuelle sable
 Klein Tischtuch sand
 Mantel individual arena

70% Pvc - 30% Pet

	cm	in
AVARITO 07	45x30	17,3/4x11,3/4

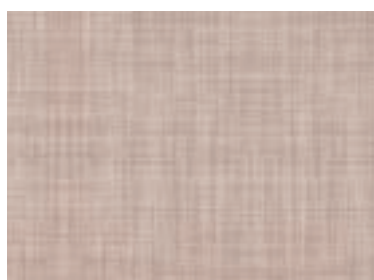

Lattiera Imperial

Imperial milkpot
Pot à lait Imperial
Milchkanne Imperial
Lechera Imperial

Acciaio Inox 18/10 - St. Steel 18/10

	cl	oz
V01 05 03 060	60	20

**Cremiera Imperial**

Imperial creamer
Crémier Imperial
Sahnekännchen Imperial
Jarrita de leche Imperial

Acciaio Inox 18/10 - St. Steel 18/10

	cl	oz
V01 05 03 015	15	5

**Caffettiera Imperial**

Imperial coffee pot
Cafetière Imperial
Kaffekanne Imperial
Cafetera Imperial

Acciaio Inox 18/10 - St. Steel 18/10

	cl	oz
V01 05 01 035	35	12
V01 05 01 060	60	20
V01 05 01 100	100	35
V01 05 01 150	150	51
V01 05 01 200	200	68

**Teiera Imperial**

Imperial teapot
Théière Imperial
Teekanne Imperial
Tetera Imperial

Acciaio Inox 18/10 - St. Steel 18/10

	cl	oz
V01 05 02 100	100	35
V01 05 02 130	130	44



Zuccheriera Imperial

Imperial sugar pot
 Sucrier Imperial
 Zuckerdose Imperial
 Azucarero Imperial

Acciaio Inox 18/10 - St. Steel 18/10

	gr	oz
V01 05 04 200	200	7

**Zuccheriera con maniglie Imperial**

Imperial sugar pot with lid and handles
 Sucrier avec couvercle et poignées Imperial
 Zuckerdose mit Griffen und Deckel Imperial
 Azucarero con tapa y asas Imperial

Acciaio Inox 18/10 - St. Steel 18/10

	gr	oz
V01 05 04 280	280	10

**Brocca acqua Imperial**

Imperial water pitcher
 Carafe à eau Imperial
 Wasserkrug Imperial
 Jarra agua Imperial

Acciaio Inox 18/10 - St. Steel 18/10

	cl	oz
V01 05 08 200	200	68

**Caraffa termica Imperial**

Imperial thermal beverage server
 Carafe thermos Imperial
 Thermoskanne Imperial
 Jarra térmica Imperial

Acciaio Inox 18/10 - St. Steel 18/10

	cl	oz
V01 05 08 T06	75	25
V01 05 08 T10	100	35
V01 05 08 T15	150	51
V01 05 08 T20	200	68



Caffettiera Daily

Daily coffee pot
 Cafetière Daily
 Daily Kaffekanne
 Cafetera Daily

Acciaio inossidabile - St. Steel

	tazze/cup	cl
906 05 044	2	15
906 05 045	4	30
906 05 045X	5	45
906 05 046	6	65
906 05 047	9	110

**Lattiera Daily**

Daily milkpot
 Pot à lait Daily
 Daily Milchkanne
 Lechera Daily

Acciaio inossidabile - St. Steel

	tazze/cup	cl
906 05 048	2	15
906 05 049	4	30
906 05 049X	5	45
906 05 050	6	65
906 05 051	9	110

**Zuccheriera Daily**

Daily sugar pot
 Sucrier Daily
 Daily Zuckerdose
 Azucarero Daily

Acciaio inossidabile - St. Steel

906 05 064	gr 200
------------	-----------



Portacannucce

Straw holder
Porte-pailles
Trinkhalmbehälter
Portapajitas

Acciaio Inox 18/10 - St. Steel 18/10

	ø cm	ø in	H. cm	H. in
V01 05 71 011	9	3,1/2	11	4,3/8

**Portacucchiaini**

Tea spoon holder
Porte-cuillères à café
Kaffeelöffelbecher
Portacucharas café

Acciaio Inox 18/10 - St. Steel 18/10

	ø cm	ø in	H. cm	H. in
V01 05 71 008	9	3,1/2	8	3,1/8

**Portabustine zucchero/the**

Rectangular sugar tray
Sucrier rectangulaire
Zucker-Behälter
Azucarero rectangular

Acciaio Inox 18/10 - St. Steel 18/10

	cm	in	H. cm	H. in
V78 05 04 PBU	10x6,5	4	3,5	1,3/8

**Passatè (colino tè) con coppetta**

Tea strainer
Passoire à the
Teesieb
Colador de te

Acciaio Inox 18/10 - St. Steel 18/10

	cm	H. cm	in	H. in
V01 05 91 001	9,5x5	3	3,3/4x2	1,1/8



Portauovo

Egg cup
Coquetier
Eierbecher
Huevera

Acciaio Inox - St. Steel

	∅ cm	∅ in
V01 05 71 001	8,6	3,3/8

**Burriera piccola con coperchio**

Small butter dish with cover
Petit beurrier avec cloche
Klein Butterschale mit Deckel
Mantequera pequeña con tapa

Acciaio Inox 18/10 - St. Steel 18/10

	∅ cm	∅ in
V01 05 09 107	7	2,3/4

**Burriera con coperchio**

Butter dish with cover
Beurrier avec cloche
Butterschale mit Deckel
Mantequera con tapa

Acciaio Inox 18/10 - St. Steel 18/10

	∅ cm	∅ in
V01 05 09 115	15	6

**Portasalatini 3 scomparti**

3-tier snack/relish dish
Porte-biscuits salés à 3 compartiments
Salzgebäckschale, 3-tlg
Entremesera 3 sectores

Acciaio Inox 18/10 - St. Steel 18/10

	∅ cm	∅ in
V01 05 41 003	10,5	4,1/8



Portamarmellata per 4 confezioni

4-jar jam holder

Porte-confiture pour 4 pots

Konfitürenschaale, 4 tlg

Dispensador de mermelada para 4 botes

Acciaio Inox 18/10 - St. Steel 18/10

	cm	in
V76 05 09 001	18x45	7,1/8x1,3/4

**Portamarmellata 3 scomparti**

3-tier jam dish

Porte-confiture à 3 compartiments

Konfitürenschaale, 3 tlg

Dispensador de mermelada 3 sectores

Acciaio Inox 18/10 - St. Steel 18/10

	∅ cm	H. cm	∅ in	H. in
V01 05 09 003	6	13	2,3/8	5,1/8

**Portamarmellata 6 scomparti**

6-tier jam dish

Porte-confiture à 6 compartiments

Konfitürenschaale, 6 tlg

Dispensador de mermelada 6 sectores

Acciaio Inox 18/10 - St. Steel 18/10

	∅ cm	H. cm	∅ in	H. in
V01 05 09 006	6	17,5	2,3/8	6,7



Sottopiatto bordo inglese

Show plate with English decoration

Plat à présentation avec décoration anglaise

Platzteller mit englischer Dekoration

Plato de presentación con borde inglés

Acciaio Inox 18/10 - St. Steel 18/10

	∅ cm	∅ in	∅ interno cm	∅ interno in
V01 05 25 132	31,5	12,3/8	19,5	7,5/8

**Sottopiatto liscio**

Show plate, plain

Plat à présentation simple

Platzteller

Plato de presentación liso

Acciaio Inox 18/10 - St. Steel 18/10

	∅ cm	∅ in	∅ interno cm	∅ interno in
V01 05 25 032	31	12,1/4	20	7,1/4

**Sottobottiglia**

Bottle coaster

Sous bouteille

Flaschenuntersatz

Posabotella

Acciaio Inox 18/10 - St. Steel 18/10

	∅ cm	∅ in
V01 05 21 014	12,5	5

**Sottobicchiere**

Glass coaster

Sous verre

Untersatz

Posavasos

Acciaio Inox 18/10 - St. Steel 18/10

	∅ cm	∅ in
V01 05 21 011	11	4,3/8





Anello adattatore

Adjusting ring
Bague de réglage
Einsatzring
Anillo adaptador

Acciaio Inox 18/10 - St. Steel 18/10

	cm	in
① V01 05 43 540	10,5	4,1/8
② 305 05 43 540	13 cm	5,1/8



Coppetta interna

Supreme inside cup
Coupe intérieure
Schale
Copita interior

Acciaio Inox 18/10 - St. Steel 18/10

	cm	in
V01 05 43 562	10,5	4,1/8



Piattino portaburro

Butter dish
Plat à beurre
Butterschale
Platito mantequilla

Acciaio Inox 18/10 - St. Steel 18/10

	ø cm	ø in
V01 05 43 648	13	5,1/8



Griglia portaburro

Butter grid
Grille porte-beurre
Buttergitter
Parrilla mantequilla

Acciaio Inox 18/10 - St. Steel 18/10

	ø cm	ø in
V01 05 43 539	13	5,1/8



Coppa esterna base

Supreme outside base cup
Coupe base extérieure Supreme
Schale auf Fuß
Copa exterior base Supreme

Acciaio Inox 18/10 - St. Steel 18/10

	ø cm	ø in
V01 05 43 130	13	5,1/8



Coppa Supreme completa con anello in filo

Supreme cup with wire ring
Coupe Supreme avec anneau en fil
Hummer-/Cocktailschale
Copa Supreme, completa con anillo en hilo

Acciaio Inox 18/10 - St. Steel 18/10

	ø cm	H. cm	ø in	H. in
V01 05 43 C13	13	8,5	5,1/8	3,3/8
3 Pezzi - 3 Pieces				



Coppa supreme

Supreme cup
Coupe à suprême
Copa supreme
Schale Supreme

Acciaio Inox 18/10 - St. Steel 18/10

	ø cm	H. cm	ø in	H. in
V01 05 43 C13N	13	8,5	5,1/8	3,3/8

Coppa macedonia Imperial

Fruit salad cup
Coupe à dessert
Obstsalatschale
Copa macedonia

Acciaio Inox 18/10 - St. Steel 18/10

	ø cm	ø in	H. cm	H. in
V01 05 43 125	12,5	5	5,5	2

**Coppa gelato Imperial**

Imperial ice cream cup
Coupe à glace Imperial
Eisschale Imperial
Copa helado Imperial

Acciaio Inox 18/10 - St. Steel 18/10

	ø cm	ø in	H. cm	H. in
V01 05 43 010	9,5	3,3/4	10	4

**Piattino sottocoppa**

Cup saucer
Plat sous coupe
Untersatz
Platito posacopa

Acciaio Inox 18/10 - St. Steel 18/10

	ø cm	ø in
V01 05 21 013	13	5,1/8

**Portafiori**

Flower vase
Vase à fleurs
Blumenvase
Florero

Acciaio Inox 18/10 - St. Steel 18/10

	H. cm	H. in
V01 05 19 015	16,5	6,1/2



Vassoio multiuso

Multipurpose tray
Plateau universelle
Universale Platte
Bandeja universal

Acciaio Inox 18/10 - St. Steel 18/10

	cm	in
CI 3005	24x9,5	9,1/2x3,3/4

**Salsiera con piattino**

Sauce boat with underliner
Saucière avec soucoupe
Soßenschüssel mit Tellerchen
Salsiera con platito

Acciaio Inox 18/10 - St. Steel 18/10

	cl	oz
V61 05 12 030	30	10

**Salsiera**

Sauce boat
Saucière
Soßenschüssel
Salsiera

Acciaio Inox 18/10 - St. Steel 18/10

	cl	oz
CI 25401	10	3
CI 25402	20	7
CI 25403	30	10

**Cloche**

Dome cover
Cloche
Speiseglocke
Campana

Acciaio Inox 18/10 - St. Steel 18/10

	ø cm	ø in
V01 05 53 024	24	9,1/2
V01 05 53 026	26	10,1/4
V01 05 53 028	28	11
V01 05 53 030	30	11,3/4



Portatovaglioli Imperial

Imperial napkin holder
 Porte-serviette Imperial
 Serviettenhalter Imperial
 Servilletero Imperia

Acciaio Inox 18/10 - St. Steel 18/10

	cm	H. cm	in	H. in
V01 05 71 105	10,5	9	4,1/8	3,1/2



Portatovaglioli Square

Square napkin holder
 Porte-serviettes Square
 Serviettenhalter Square
 Servilletero Square

Acciaio Inox 18/10 - St. Steel 18/10

	cm	H. cm	in	H. in
V76 05 71 001	11x4	8	4,3/8x1,2/3	3,1/8

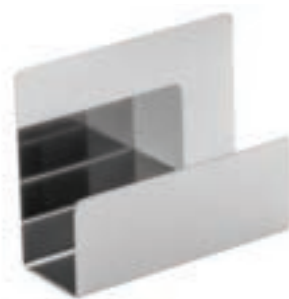

Portatovaglioli quadrato

Napkin holder, square
 Porte-serviette carré
 Viereckiger Serviettenhalter
 Servilletero cuadrado

Acciaio Inox 18/10 - St. Steel 18/10

	cm	H. cm	in	H. in
V01 05 71 190	19x19	7	7,1/2x7,1/2	2,3/4

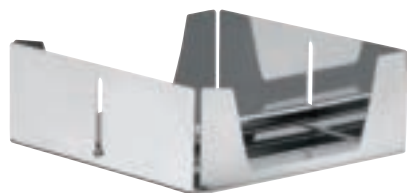

Porta kleenex

Kleenex holder
 Porte-kleenex
 Taschentücherhalter
 Porta kleenex

Acciaio Inox 18/10 - St. Steel 18/10

	cm	H. cm	in	H. in
V01 05 71 002	22x12	5,5	8,5/8x4,3/4	2,1/8



Lavadita

Finger bowl
 Rince-doigts
 Fingerschale
 Lavadedos

Acciaio Inox 18/10 - St. Steel 18/10

	ø cm	ø in
V01 05 43 012	12	4,3/4



Portatovaglioli da banco verticale

Vertical napkin holder
 Porte-serviettes vertical
 Vertikaler Thekenserviettenhalter
 Servilletero cuadrado vertical

Acciaio Inox 18/10 - St. Steel 18/10

	cm	H. cm	in	H. in
906 05 008	8,5x11	16	3,3/8x4,3/8	6,1/4



Coperchio legumiera/zuppiera

Cover for vegetable dish/soup tureen

Couvercle pour soupière/légumier

Deckel für Suppen-Gemüseschüssel

Tapa legumbrera/sopera

Acciaio Inox 18/10 - St. Steel 18/10

	ø cm	ø in
V01 05 15 C14	14	5,1/2
V01 05 15 C18	18	7,1/8
V01 05 15 C22	22	8,5/8
V01 05 15 C24	24	9,1/2
V01 05 15 C26	26	10,1/4
V01 05 15 C28	28	11
V01 05 15 C30	30	11,3/4

**Zuppiera**

Soup tureen

Soupière

Suppenschüssel

Sopera

Acciaio Inox 18/10 - St. Steel 18/10

	ø cm	ø in	lt	oz
V01 05 15 Z14	14	5,1/2	0,75	25
V01 05 15 Z18	18	7,1/8	1,5	50
V01 05 15 Z22	22	8,5/8	2,5	85
V01 05 15 Z24	24	9,1/2	3,5	118
V01 05 15 Z26	26	10,1/4	4,25	144
V01 05 15 Z28	28	11	5,25	178
V01 05 15 Z30	30	11,3/4	6,5	220

**Legumiera**

Vegetable dish

Légumier

Gemüseschüssel

Legumbrera

Acciaio Inox 18/10 - St. Steel 18/10

	ø cm	ø in	lt	oz
V01 05 15 L14	14	5,1/2	0,8	27
V01 05 15 L18	18	7,1/8	1,4	47
V01 05 15 L22	22	8,5/8	1,9	64
V01 05 15 L24	24	9,1/2	2,8	94,6
V01 05 15 L26	26	10,1/4	3,8	128,5
V01 05 15 L28	28	11	4,8	162



Segnatavolo a colonna (portanumero)

Table number stand, column-shaped

Support numéro de table à colonne

Tischnummerständer

Número sobremesa a columna

Acciaio Inox 18/10 - St. Steel 18/10

	H. cm	H. in
V01 05 19 019	19	7,1/2
V01 05 19 046	45	17,3/4

**Cavalletto portaetichetta per buffet
(senza tavoletta - without black tag)**

Buffet easel for tags

Chevalet porte-nom pour buffet

Aufsteller Produktinfo

Soporte caballete para etiqueta para buffet

Inox 18/10 - St. Steel

	H. cm	H. in
V01 05 19 001	14,5	5,3/4

Tavoletta nera per cavalletto

Black tag for easel

Plaque pour chevalet noir

Schild für Produktinfo

Etiqueta negra para soporte caballete

Plexiglass

	H. cm	H. in
V01 12 19 001	10x7,5	4x3

**Portatoast in filo**

Toast holder, steel wire

Porte-toasts en fil

Toastständer

Portatostadas en hilo

Acciaio Inox 18/10 - St. Steel 18/10

	cm	H. cm	in	H. in
V01 05 71 195	19,5	15	7,5/8	6



Formaggiara Imperial

Imperial grated-cheese holder
 Ravier à parmesan Imperial
 Käsedose Imperial
 Quesera Imperial

Acciaio Inox 18/10 - St. Steel 18/10

	cm	H. cm	in	H. in
V01 05 13 001	15,5x12,5	8	6,1/8x4,7/8	3,1/8

**Oliera 4 pezzi Imperial**

Imperial oil & vinegar cruet set, 4-piece
 Ménagère Imperial, 4 pièces
 Menage, 4-tlg Imperial
 Servicio de mesa Imperial, 4 piezas

Acciaio Inox 18/10 - St. Steel 18/10

	cm	H. cm	in	H. in
V01 05 11 005	16,5x13,5	23	6,1/2x5,3/8	9

**Oliera 2 pezzi Imperial**

Imperial oil & vinegar cruet set, 2-piece
 Ménagère Imperial, 2 pièces
 Menage, 2-tlg Imperial
 Servicio de mesa Imperial, 2 piezas

Acciaio Inox 18/10 - St. Steel 18/10

	cm	H. cm	in	H. in
V01 05 11 002	14,5x10	23	5,3/4x3,7/8	9

**Spargi sale/pepe singolo Imperial**

Imperial salt/pepper shaker
 Salière/poivrière individuelle Imperial
 Salz/Pfefferstreuer Imperial
 Salero/pimentero individual Imperial

Acciaio Inox 18/10 - St. Steel 18/10

	Ø cm	H. cm	Ø in	H. in
V01 05 12 001	3,5	9	1,3/8	3,1/2



Formaggiera 2000

2000 cheese bowl

Fromagère 2000

Käsedose 2000

Quesera 2000

Acciaio Inox 18/10 - St. Steel 18/10

	cm	H. cm	in	H. in
V61 05 13 001	13x9	7,5	5,1/8x3,1/2	3

**Oliera 5 pezzi Menage**

Menage oil & vinegar cruet set, 5-piece

Ménagère Menage, 5 pièces

Menage, 5-tlg

Servicio de mesa Menage, 5 piezas

Acciaio Inox - St. Steel

	cm	H. cm	in	H. in
V12 06 11 005	15x11,5	22	5,7/8x 4,1/2	8,5/8

**Tris sale, pepe e stecchi Inox**

Salt and pepper shakers and toothpick holder, plain

Salière, poivrière et porte cure-dents simples

Salz/Pfefferstreuer mit Zahnstochträger, Edelstahl

Tris salero, pimentero y palillero Inox

Acciaio Inox - St. Steel

	cm	H. cm	in	H. in
V12 06 12 003	8,5x7,5	14,5	3,3/8x3	5,3/4



Sale/pepe Square

Glass cruet salt spreader Square
 Verre pour salière Square
 Salzstreuer mit
 Vidrio salero Square

Acciaio Inox - St. Steel

	cm	in	H. cm	H. in
V76 05 12 002	9,5x4,5	3,3/4x1,3/4	12,5	5

**Oliera 2 pz olio/aceto Square**

Glass cruet oil/vinegar set Square
 Burette huile/vinaigre Square
 Essig/Ölglas flaschen mit
 Alcuza aceite/vinagre Square

Acciaio Inox - St. Steel

	cm	in	H. cm	H. in
V76 05 11 002	12,5x5,5	5x2,1/8	20	7,7/8

**Formaggiera Square**

Cheese bowl Square
 Ravier a parmesan Square
 Käsedose Square
 Quesera Square

Acciaio Inox - St. Steel

	cm	in	H. cm	H. in
V76 05 13 001	8,5x9	3,3/8x3,1/2	8,5	3,3/8



Portabottiglie olio/aceto con spargisale/pepe

Oil and vinegar bottle rack with salt and pepper shakers

Porte bouteilles huile-vinaigre, salière, poivrière

Essig/Ölflaschenträger, Salz/Pfeffersteuer

Portabotellas aceite y vinagre, salero, pimentero

Acciaio Inox - St. Steel

	cl	oz	cm
AVARI 060 A	25	9	12x5,5x25
AVARI 061 A	50	17,5	14x7x81

**Portabottiglie olio/aceto**

Oil and vinegar bottle rack

Porte bouteilles huile-vinaigre

Essig/Ölflaschenträger

Portabotellas aceite y vinagre

Acciaio Inox - St. Steel

	cl	oz	cm
AVARI 060	25	9	12x6,5x25
AVARI 061	50	17,5	14,5x7,5x32

**Oliera**

Oil dispenser

Huilière

Ölbehälter

Aceitera grande

Acciaio Inox - St. Steel

	lt	oz
AVARI 071	0,5	17,5
AVARI 072	1,0	35



Macinapepe

Pepper/salt mill
 Moulin à poivre/sel
 Pfeffermühle/Salzmühle
 Molinillo pimienta/sal

Acrilico + Ceramica + Al / Acrylic + Ceramic + Aluminum

	cm	H. cm	in	H. in
AVARI075A	4x4	9	1,5/8x1,5/8	3,1/2
AVARI075B	4x4	12	1,5/8x1,5/8	4,3/4

**Macinapepe/sale**

Pepper/salt mill
 Moulin à poivre/sel
 Pfeffermühl/Salzmühle
 Molinillo pimienta/sal

Acrilico + Ceramica + Al / Acrylic + Ceramic + Aluminum

	ø cm	H. cm	in	H. in
AVARI073	5	16	2	6,1/4
AVARI075	6	20,5	2,3/8	8



Oliera Pasha

Pasha oil & vinegar cruet set
Ménagère Pasha
Menage Pasha
Servicio de mesa Pasha

PP+vetro / PP+glass

V02 12 11 004 07

Rosso - Red

V02 12 11 004 13

Bianco - White

V02 12 11 004 47

Tortora - Taupe



Formaggiera Pasha con vaso vetro

Pasha grated-cheese holder
Ravier à parmesan Pasha
Käsedose Pasha
Quesera Pasha

PP+vetro / PP+glass

V02 12 13 001 07

Rosso - Red

V02 12 13 001 13

Bianco - White

V02 12 13 001 47

Tortora - Taupe



Oliera Jolly

Jolly oil & vinegar cruet set

Ménagère Jolly

Menage Jolly

Servicio de mesa Jolly

PP+vetro / PP+glass**V10 12 11 004 38**

Avio - Avio

V10 12 11 004 40

Rosso - Red

V10 12 11 004 47

Tortora - Taupe

**Formaggiera Jolly**

Jolly grated-cheese holder

Ravier à parmesan Jolly

Käsedose Jolly

Quesera Jolly

PP + PS**V10 12 13 001 38**

Avio - Avio

V10 12 13 001 40

Rosso - Red

V10 12 13 001 47

Tortora - Taupe



Vassoio tondo bar

Round bar tray
 Plateau rond bar
 Austellplatte, rund
 Bandeja redonda bar

Acciaio Inox 18/10 - St. Steel 18/10

	∅ cm	∅ in
V01 05 23 T32	32	12,5/8
V01 05 23 T38	38	15
V01 05 23 T46	46	18,1/8
V01 05 23 T54	54	21,1/4



Vassoio tondo bar con maniglie

Round bar tray with handles
 Plateau rond bar avec poignées
 Austellplatte mit Griffen, rund
 Bandeja redonda bar con asas

Acciaio Inox 18/10 - St. Steel 18/10

	∅ cm	∅ in
V01 05 23 T32M	32	12,5/8
V01 05 23 T38M	38	15
V01 05 23 T46M	46	18,1/8
V01 05 23 T54M	54	21,1/4



Vassoio tondo con bordo Basic

Basic round tray
 Plateau rond Basic
 Austellplatte, rund Basic
 Bandeja redonda Basic

Acciaio Inox 18/10 - St. Steel 18/10

	∅ cm est.	∅ cm int.	∅ in ext.	∅ in int.
V01 05 23 TB31	31	27	12,1/4	10,5/8
V01 05 23 TB36	36	30	14,1/8	11,3/4
V01 05 23 TB41	41	35	16,1/8	13,3/4



Vassoio birra

Beer tray
 Plateau à bière
 Bierplatte
 Bandeja para cerveza

Acciaio Inox 18/10 - St. Steel 18/10

	∅ cm	∅ in
CI 5412	40	15,3/4



Vassoio rettangolare gastronorm

Gastronorm tray, rectangular
 Plateau rectangulaire Gastronorm
 Ausstellplatte, rechteckig, Gastronorm
 Bandeja rectangular Gastronorm

Acciaio Inox 18/10 - St. Steel 18/10

	cm	in
V01 05 23 G12	26,5x32,5	10,3/8x12,3/4
V01 05 23 G11	53x32,5	20,7/8x12,3/4
V01 05 23 G21	65x53	25,5/8x20,7/8

**Vassoio rettangolare gastronorm con maniglie**

Gastronorm tray with handles, rectangular
 Plateau rectangulaire Gastronorm avec poignées
 Ausstellplatte mit Griffen, rechteckig, Gastronorm
 Bandeja rectangular Gastronorm con asas

Acciaio Inox 18/10 - St. Steel 18/10

	cm	in
V01 05 23 G12M	32,5x26,5	12,3/4x10,3/8
V01 05 23 G11M	53x32,5	20,7/8x12,3/4
V01 05 23 G21M	65x53	25,5/8x20,7/8

**Vassoio rettangolare Basic**

Gastronorm tray, rectangular
 Plateau rectangulaire Gastronorm
 Ausstellplatte, rechteckig Gastronorm
 Bandeja rectangular Gastronorm

Acciaio Inox 18/10 - St. Steel 18/10

	cm	in
V01 05 23 GB12	26,5x32,5	10,3/8x12,3/4
V01 05 23 GB11	53x32,5	20,7/8x12,3/4
V01 05 23 GB21	65x53	25,5/8x20,7/8

**Vassoio sovrapponibile gastronorm rettangolare (1 pz - 1 pc)**

Stackable gastronorm rectangular tray
 Plateau empilable gastronorme rectangulaire avec poignées
 Gastronorm Tablett - rund und stapelbar
 Bandeja rectangular gastronorm apilable

Acciaio Inox 18/10 - St. Steel 18/10

	cm	in
V01 05 23 G11S	53x32,5	20,7/8x12,3/4
V01 05 23 G21S	65x53	25,5/8x20,7/8



Vassoio rettangolare bar con bordo

Bar tray with edge, rectangular
 Plateau rectangulaire bar avec rebord
 Austellplatte, rechteckig
 Bandeja rectangular bar con borde

Acciaio Inox 18/10 - St. Steel 18/10

	cm	in
V01 05 23 R30	30x24	11,3/4x9,1/2
V01 05 23 R35	35x29	13,3/4x11,1/2
V01 05 23 R40	40x31	15,3/4x12,1/4
V01 05 23 R45	45x34	17,3/4x13,3/8
V01 05 23 R52	52x40	20,1/2x15,3/4
V01 05 23 R62	62x48	24,3/8x19



Vassoio rettangolare bar senza bordo

Bar tray without edge, rectangular
 Plateau rectangulaire bar sans rebord
 Austellplatte rechteckig
 Bandeja rectangular bar sin borde

Acciaio Inox 18/10 - St. Steel 18/10

	cm	in
V03 05 23 R27	27x21	10,5/8x8,1/4
V03 05 23 R30	30x24	11,3/4x9,1/2
V03 05 23 R35	35x28	13,3/4x11
V03 05 23 R40	40x32	15,3/4x12,5/8
V03 05 23 R45	45x35	17,3/4x13,3/4
V03 05 23 R50	50x38	19,3/4x15
V01 05 23 R65	65x45	25,5/8x17,3/4



Vassoio rettangolare bar senza bordo

Bar tray without edge, rectangular
 Plateau rectangulaire bar sans rebord
 Austellplatte rechteckig
 Bandeja rectangular bar sin borde

Acciaio Inox - St. Steel

	cm	in
V03 06 23 R27	27x21	10,5/8x8,1/4
V03 06 23 R31	30x24	11,3/4x9,1/2
V03 06 23 R36	35x28	13,3/4x11
V03 06 23 R40	40x32	15,3/4x12,5/8
V03 06 23 R45	45x35	17,3/4x13,3/4
V03 06 23 R50	50x38	19,3/4x15



Piatto portata ovale con bordo/pes

Oval platter with rim
 Plateau oval bordé
 Fuente oval con borde
 Bratenplatte, oval

Acciaio inox 18/10 - St. steel 18/10

	cm	in
V01 05 22 029	30x21	11,3/4x8,1/4
V01 05 22 034	35x24	13,3/4x9,1/2
V01 05 22 038	40x27	15,3/4x10,5/8
V01 05 22 044	45x33	17,3/4x13
V01 05 22 049	50x33	19,3/4x13
V01 05 22 059	59x40	23,1/4x15,3/4



Piatto ovale senza bordo

Plate without edge, oval
Assiette ovale sans rebord
Bratenplatte, oval
Fuente oval sin borde

Acciaio Inox 18/10 - St. Steel 18/10

	cm	in
V03 05 22 025	25x17	9,7/8x6,3/4
V03 05 22 030	30x21	11,3/4x8,1/4
V03 05 22 035	35x24	13,3/4x9,1/2
V03 05 22 040	40x27	15,3/4x10,5/8
V03 05 22 045	45x31	17,3/4x12,1/4
V03 05 22 050	50x35	19,3/4x13,3/4

**Piatto portata tondo con bordo**

Plate with edge, round
Assiette ronde avec rebord
Bratenplatte, rund mit Rand
Fuente redonda con borde

Acciaio Inox 18/10 - St. Steel 18/10

	ø cm est.	ø cm int.	ø in ext.	ø in int.
V01 05 22 T29	29	20	11,1/2	7,7/8
V01 05 22 T38	38	26	15	10,1/4

**Piatto portata pesce**

Fish plate
Assiette à poisson
Fischplatte
Fuente para pescado

Acciaio Inox - St. Steel

	cm	in
V01 05 22 P60	60x24,5	23,5/8x9,5/8
V01 05 22 P70	70x28,5	27,1/2x11,1/4



WINE
&
BAR

WINE & BAR



Secchio Cacao con manico in ecopelle

Cacao bucket with leather handle
 Seau Cacao avec manche en cuir
 Champagnekühler mit Eimer Cacao (Griff aus Leder)
 Cubo Cacao con mango de cuero

Acciaio Inox 18/10 - St. Steel 18/10 + E.P. - E.L.

	Ø cm	H. cm	Ø in	H. in
V36 05 20 M01	19	19,5	7,1/2	7,5/8

**Secchio Cacao con pomolo**

Cacao bucket with knob
 Seau Cacao avec poignée
 Champagnekühler Cacao mit Knopf
 Champañera Cacao con pomo

Acciaio inox 18/10 - St. steel 18/10

	Ø cm	H. cm	Ø in	H. in
V36 05 20 P01	19	19,5	7,1/2	7,5/8

**Supporto secchio Cacao**

Cacao champagne cooler stand
 Support pour seau à champagne Cacao
 Cacao Champagnekühler Ständer
 Soporte para champañera Cacao

Acciaio inox 18/10 - St. steel 18/10

	cm	in
V36 05 20 001	59,5	23,1/2



Glacette Modern

Modern glacette
Glacette Modern
Weinkühler Modern
Enfriador de botella

Acciaio Inox - St. Steel

		∅ cm	∅ in	H. cm	H. in
V78 05 24 01 01 401	est int	12 10	4.3/4 4	19,5	7,5/8

Secchio ovale Modern

Modern Champagne cooler
Seau à champagne ovale Modern
Modern oval Champagnekühler
Champañera oval Modern

Acciaio inox 18/10 - St. steel 18/10

		∅ cm	H. cm	∅ in	H. in
V78 05 20 003		27	21,5	10,5/8	8,5/1

**Supporto secchio ovale Modern**

Champagne bucket stand
Support pour seau à champagne
Sektühlerständer
Soporte champañera

Acciaio inox 18/10 - St. steel 18/10

	cm	in	∅ cm	∅ in
V78 05 20 677	59,5	23,1/2	25,5	10





Secchio ovale Modern

Modern Champagne cooler
 Seau à champagne ovale Modern
 Modern oval Champagnekühler
 Champañera oval Modern

PVD Rame - PVD Copper

	ø cm	H. cm	ø in	H. in
V78 40 20 003	27	21,5	10,5/8	8,5/1

**Supporto secchio ovale Modern**

Champagne bucket stand
 Support pour seau à champagne
 Sektühlerständer
 Soporte champañera

PVD Rame - PVD Copper

	cm	in	ø cm	ø in
V78 40 20 677	59,5	23,1/2	25,5	10



Secchio ghiaccio Modern

Modern ice bucket
 Seau à glace Modern
 Eiswürfelbehälter Modern
 Cubo hielo Modern

Acciaio Inox - St. Steel

		ø cm	ø in	H. cm	H. in
V78 05 20 00 11 401	est	15	6	17	6,3/4
	int	13	5,1/8		

**Secchio tondo Modern**

Modern Champagne cooler
 Seau à champagne Modern
 Modern Champagnekühler
 Champañera Modern

Acciaio inox 18/10 - St. steel 18/10

		ø cm	H. cm	ø in	H. in
V78 05 20 002		24	22,5	9,1/2	8,7/8

**Supporto secchio tondo Modern**

Modern champagne cooler stand
 Support pour seau à champagne Modern
 Modern Champagnekühler Ständer
 Soporte para champañera Modern

Acciaio inox 18/10 - St. steel 18/10

	cm	in
V78 05 20 676	57	22,1/2

Secchio tondo Modern

Modern Champagne cooler

Seau à champagne Modern

Modern Champagnekühler

Champañera Modern

PVD Rame - PVD Copper

	ø cm	H. cm	ø in	H. in
V78 40 20 002	24	22,5	9,1/2	8,7/8

**Supporto secchio tondo Modern**

Modern champagne cooler stand

Support pour seau à champagne Modern

Modern Champagnekühler Ständer

Soporte para champañera Modern

PVD Rame - PVD Copper

	cm	in
V78 40 20 676	57	22,1/2





Glacette doppio corpo Wine&Bar

Wine&Bar double wall bottle cooler

Rafraîchisseur à bouteille/vin double paroi Wine&Bar

Weinkühler, doppelwandig Wine&Bar

Enfriador de botella doble pared Wine&Bar

Acciaio Inox 18/10 - St. Steel 18/10

	ø cm	ø in	H. cm	H. in
V78 05 24 014	13	5,1/8	21	8,1/4

**Shaker**

Cocktail shaker

Shaker

Cocktail Shaker

Coctelera

Acciaio Inox 18/10 - St. Steel 18/10

	lt	oz
V78 05 81 SHA	0,7	17

PVD Rame - PVD Copper

	lt	oz
V78 40 81 SHA	0,7	17

**Bicchieri Boston**

Boston mixing container

Verre en métal pour Boston

Boston Metallbecher

Vaso en metal para Boston

Acciaio Inox 18/10 - St. Steel 18/10**Vetro - Glass**

	lt	oz	
V78 05 81 SHA 2B 0,7	0,7	17	acciaio
V78 08 81 SHA 2B 0,7	0,7	17	vetro

PVD Rame - PVD Copper

	lt	ø cm	
V78 40 81 SHA 2B 0,7	0,7	17	rame



Secchiello ghiaccio doppio corpo

Double wall ice bucket

Seau à glace double paroi

Eiswürfelbehälter, doppelwandig

Cubo hielo doble pared

Acciaio Inox 18/10 - St. Steel 18/10

	ø cm	ø in	H. cm	H. in
V78 05 20 014	13	5,1/8	18	7,1/8

**Versavino**

Red wine holder

Porte-bouteille

Portabotella

Rotweinwiege

Acciaio Inox 18/10 - St. Steel 18/10

	cm	in
V01 05 24 022	30	11,3/4

**Scoladecanter**

Decanter wine stand

Egouttoir de carafe

Karaffentrockner

Soporte para decantador

Acciaio Cromato - Chromed Steel

	H. cm	H. in
V01 05 24 020	30	11,3/4



Secchio ghiaccio Imperial

Imperial ice bucket

Seau à glace Imperial

Imperial Eiswürfelbehälter

Cubo hielo Imperial

Acciaio Inox 18/10 - St. Steel 18/10

	ø cm	ø in	H. cm	H. in
V01 05 20 013	13,5	5,3/8	13	5,1/8

**Secchio champagne Imperial**

Imperial champagne cooler

Seau à champagne Imperial

Imperial Champagnekühler

Champañera Imperial

Acciaio Inox - St. Steel

	ø cm	ø in	H. cm	H. in
V01 05 20 020	21	8,1/4	20	7,7/8

**Supporto secchio Imperial**

Imperial champagne cooler stand

Support pour seau à champagne Imperial

Imperial Champagnekühler Ständer

Soporte para champañera Imperial

Acciaio Inox 18/10 - St. Steel 18/10

	ø cm	ø in	H. cm	H. in
V01 05 20 675	21	8,1/4	61	24

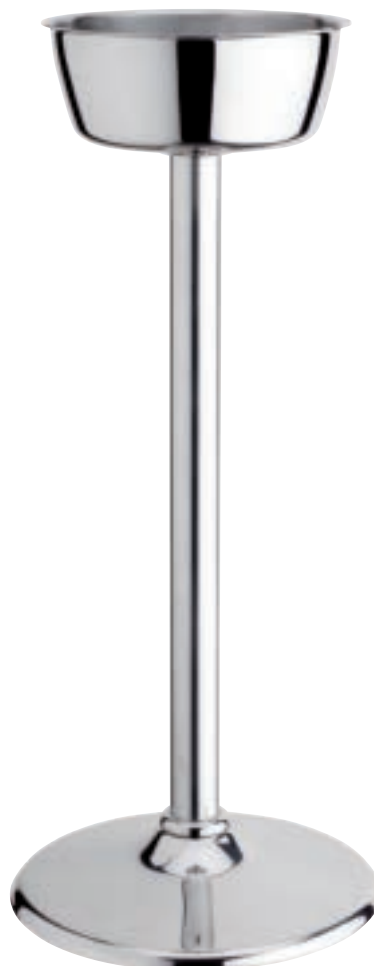

Secchio ghiaccio Basic

Basic ice bucket
 Seau à glace Basic
 Eiskühler Basic
 Cubo hielo Basic

Acciaio Inox - St. Steel

	ø cm	ø in	H. cm	H. in
906 05 012	13	5,1/8	13	5,1/8

**Secchio champagne Basic**

Basic champagne bucket
 Seau à champagne Basic
 Sektkühler Basic
 Champañera Basic

Acciaio Inox - St. Steel

	ø cm	ø in	H. cm	H. in
906 05 013	21,5	8,1/2	21	8,1/4

**Supporto secchio Basic**

Basic champagne cooler stand
 Support pour seau à champagne Basic
 Basic Champagnekühler Ständer
 Soporte para champañera Basic

Acciaio Inox 18/10 - St. Steel 18/10**Acciaio Inox - St. Steel**

	ø cm	ø in	H. cm	H. in
V01 05 20 674	21	8,1/4	63	24,3/4



Cocktail shaker Basic

Basic cocktail shaker
Cocktail shaker Basic
Cocktail Shaker Basic
Coctelera Basic

Acciaio Inox - St. Steel

	lt	oz
V78 05 81 SHA11 401	0,5	17

**Misurino Basic**

Basic jigger
Mésure Basic
Meßbecher Basic
Medida bar Basic

Acciaio Inox - St. Steel

	ml	oz
V78 05 81 DOS1	25-50 ml	0.8-1.7

PVD Rame - PVD Copper

V78 40 81 DOS1

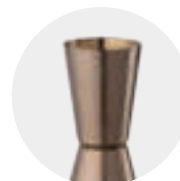
**Molla ghiaccio Modern**

Ice tongs
Pince à glaçons
Eiszange
Pinzas hielo

Acciaio Inox - St. Steel

	mm	in
903 05 81 MGH	200	7,7/8

PVD Rame - PVD Copper

903 40 81 MGH

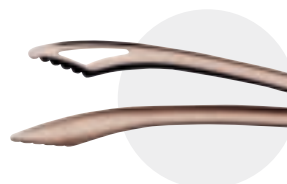

Molla ghiaccio Lux

Ice tongs
Pince à glace
Eiszange
Pinzas hielo

Acciaio Inox 18/10 - St. Steel 18/10

	mm	in
903 05 81 001	126	4,7/8

PVD Rame - PVD Copper **903 40 81 001**

**Filtro cocktail Basic**

Basic cocktail strainer
Passoire à cocktail Basic
Barsieb Basic
Colador de cóctel Basic

Acciaio Inox - St. Steel

	mm	in
V78 05 81 FCO1	140	5,1/2

PVD Rame - PVD Copper **V78 40 81 FCO1**

**Vassoio da banco/bar pasticceria**

Bar/pastry tray
Plateau bar/pâtisserie
Konditoreiplatte
Bandeja bar/pastelería

Acciaio inox 18/10 - St. steel 18/10

	cm	H. cm	in	H. in
V01 05 23 P06	35x10	0,8	13.3/4x4	0,31

PVD Rame - PVD Copper **V01 40 23 P06**



Secchio spumante 1 bottiglia

Champagne bucket, 1-bottle
 Seau à champagne 1 bouteille
 Champagneschale (Für 1Flasche)
 Champañera 1 botella

		cm	H. cm	in	H. in
V81 12 20 001	PMMA-Transparent	22x16	23,5	8,5/8x6,1/4	9,1/4
V81 12 20 004	PS - Transparent	22x16	23,5	8,5/8x6,1/4	9,1/4
V81 12 20 007	PS Bianco - White	22x16	23,5	8,5/8x6,1/4	9,1/4

**Secchio spumante Magnum**

Magnum bucket
 Seau Magnum
 Champagneschale Magnum
 Champañera Magnum

		cm	H. cm	in	H. in
V81 12 20 002	PMMA-Transparent	27,9x17,3	23,4	11x6,7/8	9,1/4
V81 12 20 005	PS - Transparent	27,9x17,3	23,4	11x6,7/8	9,1/4
V81 12 20 008	PS Bianco - White	27,9x17,3	23,4	11x6,7/8	9,1/4

**Secchio spumante Jeroboam**

Jeroboam bucket
 Seau Jeroboam
 Champagneschale Jeroboam
 Champañera Jeroboam

		cm	H. cm	in	H. in
V81 12 20 003	PMMA-Transparent	48,2x20,9	24,3	19x8,1/4	9,5/8
V81 12 20 006	PS - Transparent	48,2x20,9	24,3	19x8,1/4	9,5/8
V81 12 20 009	PS Bianco - White	48,2x20,9	24,3	19x8,1/4	9,5/8



Coppa punch

Punch bowl
 Bol à punch
 Punschschale
 Champañera

Acciaio Inox 18/10 - St. Steel 18/10

	ø cm	ø in	lt	oz
V77 05 52 PUN	40	15,3/4	13	439,5

**PVD Rame - PVD Copper**

	ø cm	ø in	lt	oz
V77 40 52 PUN	40	15,3/4	13	439,5

**Coppa champagne con base**

Champagne-bottle holder with base
 Coupe à champagne avec base
 Champagnerschale mit Basis
 Champañera con base

Acciaio Inox 18/10 - St. Steel 18/10

	ø cm	ø in	lt	oz
V77 05 52 PUN3	53	20,7/8	25	845



Coppa punch doppio corpo

Punch bowl double-wall
 Bol à punch double paroi
 Doppelwandiger Punschschale
 Champañera doble pared

Acciaio Inox 18/10 - St. Steel 18/10

	ø cm	ø in	lt	oz
V77 05 52 PUN2	39	15,3/8	10	338

**Coppa champagne**

Champagne bottle holder
 Coupe à champagne
 Champagnerschale
 Champañera

Acciaio Inox 18/10 - St. Steel 18/10

	ø cm	ø in	lt	oz
V77 05 52 PUN1	53	20,7/8	25	845



Portacannucce

Straw holder
 Porte-pailles
 Trinkhalmbehälter
 Portapajitas

Acciaio Inox 18/10 - St. Steel 18/10

	ø cm	ø in	H. cm	H. in
V01 05 71 011	9	3,1/2	11	4,3/8

**Portacucchiaini**

Tea spoon holder
 Porte-cuillères à café
 Kaffeelöffelbecher
 Portacucharas café

Acciaio Inox 18/10 - St. Steel 18/10

	ø cm	ø in	H. cm	H. in
V01 05 71 008	9	3,1/2	8	3,1/8

**Vassoio tondo bar**

Round bar tray
 Plateau rond bar
 Austellplatte, rund
 Bandeja redonda bar

Acciaio Inox 18/10 - St. Steel 18/10

	ø cm	ø in
V01 05 23 T32	32	12,5/8
V01 05 23 T38	38	15

**PVD Rame - PVD Copper**

	mm	in
V01 40 23 T32	32	12,5/8
V01 40 23 T38	38	15



Portabustine zucchero/tè

Packed sugar/tea holder
 Conteneur sachets de sucre/té
 Zucker und-Teebeutel Behälter
 Portasobres de azúcar/té

Acciaio Inox 18/10 - St. Steel 18/10

	cm	in	H. cm	H. in
V78 05 04 PBU	10x6,5	3,7/8x2,1/2	3,5	1,3/8

**Spargicacao con coperchio in plastica**

Cocoa shaker with plastic cover
 Saupoudreuse de cacao à couvercle en plastique
 Kakaostreuer mit Plastikdeckel
 Espolvoreador con tapa en plástico

Acciaio Inox 18/10 - St. Steel 18/10

	ø cm	ø in
909 05 XX 028	5,3	2,1/8

**Denocciatore**

Olive and cherry pitter
 Dénoyauteur à olives Entkerner
 Entkerner
 Deshuesador aceitunas

Acciaio Inox 18/10 - St. Steel 18/10

	mm	in
V78 05 81 DEN	162	6,3/8



Portatovaglioli Square

Napkin holder
Porte-serviettes
Serviettenhalter
Servilletero

Acciaio Inox 18/10 - St. Steel 18/10

	cm	in	H. cm	H. in
V76 05 71 001	11x4	4,3/8x1,2/3	2	3,1/8

PVD Rame - PVD Copper V76 40 71 001

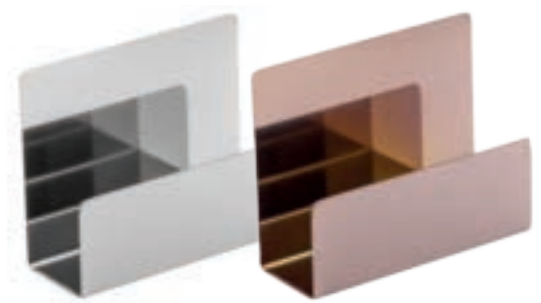
**Portatovaglioli da banco verticale**

Vertical napkin holder
Porte-serviettes vertical
Vertikaler Thekenserviettenhalter
Servilletero cuadrado vertical

Acciaio Inox 18/10 - St. Steel 18/10

	cm	in	H. cm	H. in
906 05 008	8,5x11	3,3/8x4,3/8	16	6,1/4

**Portatovaglioli Imperial**

Imperial napkin holder
Porte-serviette Imperial
Serviettenhalter Imperial
Servilletero Imperial

Acciaio Inox 18/10 - St. Steel 18/10

	cm	H. cm	in	H. in
V01 05 71 105	10,5	9	4,1/8	3,1/2



Cucchiario ghiaccio Matisse piccolo

Matisse slotted ice spoon
 Cuillère à glaçons perforée Matisse
 Kleiner Eiswürfelloffel Matisse
 Cuchara hielo perforada Matisse

Acciaio Inox 18/10 - St. Steel 18/10

	mm	in
CF1 251	170	6,5/8

PVD Rame - PVD Copper CF1 40 251

**Cucchiario multiuso Matisse grande**

Matisse slotted spoon large
 Cuillère à servir perforée Matisse grande
 Großer Universallöffel Matisse
 Cuchara para servir perforada Matisse grande

Acciaio Inox 18/10 - St. Steel 18/10

	mm	in
CF1 162	205	8,1/8

PVD Rame - PVD Copper CF1 40 162

**Cucchiario miscelatore**

Stirrer spoon
 Cuillère à mélange
 Cuchara para mezclar
 Rührer Löffel

Acciaio Inox 18/10 - St. Steel 18/10

	mm	in
V78 05 81 MES	250	9,7/8

PVD Rame - PVD Copper V78 40 81 MES



Coltello agrumi Regis

Regis citrus fruit knife
 Couteau à agrumes Regis
 Orangenmesser Regis
 Cuchillo cítricos Regis

Acciaio Inox - St. Steel

	mm	in
903 05 84 269	220	8,5/8

PVD Rame - PVD Copper 903 40 84 269

**Appetizer Double (cucchiaino forchettina)**

Double appetizer (spoon fork)
 Cuillère de mise en bouche Double (cuillère fourchette)
 Appetizerlöffel doppelt (Löffel & Gabel)
 Aperitivo Double (cuchara tenedor)

Acciaio Inox 18/10 - St. Steel 18/10

	mm	in
CF7 PDFS	122	4,3/4

PVD Rame - PVD Copper CF7 P4 0DFS

**Cucchiaino olive con fori**

Olive slotted spoon
 Cuillère de mise en bouche olives perforée
 Gelochter Oliven Löffel
 Cuchara aceitunas perforada

Acciaio Inox 18/10 - St. Steel 18/10

	mm	in
903 05 81 AOF	225	8,7/8

PVD Rame - PVD Copper 903 40 81 AOF





Set 12pz cannucce lucide + 1 scovolino

Mirror finished straw set 12-pc + 1 cleaner

Set 12pcs pailles polies +1 brosse

Set 12pzs pajitas pulidas +1 cepillo

12-teiliges Set Strohhalme; hochglanz poliert + 1 Reiniger

Acciaio Inox 18/10 - St. Steel 18/10

	L. mm	ø mm	L. in	Ø in
cannucce/ straws	215	6	8,1/2	2,3/8
scovolino / cleaner	200	6	7,7/8	2,3/8

- 9030573001 Dritte - straight - droites - rectas - gerade
- 9030573002 Con piega - pliées - dobladas - gebogen



Set 12pz cannuce lucide corte + 1 scovolino

Mirror finished straw set 12-pc + 1 cleaner
 Set 12pcs pailles polies +1 brosse
 Set 12pzs pajitas pulidas +1 cepillo
 12-teiliges Set Strohhalme; hochglanz poliert + 1 Reiniger



Acciaio Inox 18/10 - St. Steel 18/10

	L. mm	ø mm	L. in	Ø in
cannuce/ straws	150	6	6	2,3/8
scovolino / cleaner	160	6	6	2,3/8

9030573003 Dritte - straight - droites - rectas - gerade

- Copper 903057300340 Dritte - straight - droites - rectas - gerade
- Gold 903057300341 Dritte - straight - droites - rectas - gerade
- Black 903057300342 Dritte - straight - droites - rectas - gerade



Set 12pz cannuce lucide + 1 scovolino

Mirror finished straw set 12-pc + 1 cleaner
 Set 12pcs pailles polies +1 brosse
 Set 12pzs pajitas pulidas +1 cepillo
 12-teiliges Set Strohhalme; hochglanz poliert + 1 Reiniger



Acciaio Inox 18/10 - St. Steel 18/10

	L. mm	ø mm	L. in	Ø in
cannuce/ straws	215	6	8,1/2	2,3/8
scovolino / cleaner	200	6	7,7/8	2,3/8

9030573002 Con piega - pliées - dobladas - gebogen

- Copper 903057300240 Con piega - pliées - dobladas - gebogen
- Gold 903057300241 Con piega - pliées - dobladas - gebogen
- Arcobaleno 903057300281 Con piega - pliées - dobladas - gebogen



PASTRY

PASTRY

PASTRY









Alzata piccola pasticceria verticale 8 posizioni

Upright small pastry stand 8 positions
Support vertical pour petites pâtisseries 8 positions
Stehender kleiner Gebäckständer 8 Positionen
Soporte vertical para pastelería pequeña 8 posiciones

Inox 18/10 - St. Steel

	ø cm	ø in	H. cm	H. in
V36 05 41 001	12,5	5	30	11 ¾



Alzata piccola pasticceria verticale 4 posizioni

Upright small pastry stand 4 positions
Support vertical pour petites pâtisseries 4 positions
Stehender kleiner Gebäckständer 4 Positionen
Soporte vertical para pastelería pequeña 4 posiciones

Inox 18/10 - St. Steel

	ø cm	ø in	H. cm	H. in
V36 05 41 002	12,5	5	18	7





Alzata pasticceria

Petit four stand
Support à pâtisserie
Petits-Fours-Ständer
Presentación pastelería

Acciaio Inox 18/10 - St. Steel 18/10

	ø cm	H. cm	ø in	H. in
V36 05 41 012	12	13	4,3/4	5,1/8
V36 05 41 112	12	18	4,3/4	7
V36 05 41 216	16	8	6,1/4	3,1/8
V36 05 41 016	16	13	6,1/4	5,1/8
V36 05 41 116	16	18	6,1/4	7
V36 05 41 122	22	8	8,5/8	3,1/8
V36 05 41 022	22	13	8,5/8	5,1/8

PVD Oro - PVD Gold

	ø cm	H. cm	ø in	H. in
V36 41 41 112	12	18	4,3/4	7
V36 41 41 016	16	13	6,1/4	5,1/8
V36 41 41 122	22	8	8,5/8	3,1/8



Alzata pasticceria 2 piani

2-tier petit four stand

Support à pâtisserie à 2 étages

Petits-fours ständer 2-stufig

Presentación pastelería 2 pisos

Acciaio Inox 18/10 - St. Steel 18/10

	ø cm	H. cm	ø in	H. in
V36 05 41 201	16-12	17	6,1/4-4,3/4	6.3/4
V36 05 41 202	22-16	17	8,5/8-6,1/4	6.3/4

PVD Oro - PVD Gold

	ø cm	H. cm	ø in	H. in
V36 41 41 201	16-12	17	6,1/4-4,3/4	6.3/4
V36 41 41 202	22-16	17	8,5/8-6,1/4	6.3/4

**Alzata pasticceria 3 piani**

3-tier petit four stand

Support à pâtisserie à 3 étages

Kuchenständer 3-stufig

Presentación pastelería 3 pisos

Acciaio Inox 18/10 - St. Steel 18/10

	ø cm	H. cm	ø in	H. in
V36 05 41 301	22-16-12	30	8,5/8-6,1/4-4,3/4	11.3/4

PVD Oro - PVD Gold

	ø cm	H. cm	ø in	H. in
V36 41 41 301	22-16-12	30	8,5/8-6,1/4-4,3/4	11.3/4





Alzata torta

Cake stand
Presentoir à gâteau
Tortenplatte
Presentación tarta

Acciaio Inox 18/10 - St. Steel 18/10

	ø cm	H. cm	ø in	H. in
V01 05 42 122	22	15	8,5/8	6
V01 05 42 222	22	21	8,5/8	8,1/4
V01 05 42 132	32	9	12,5/8	3,1/2
V01 05 42 232	32	15	12,5/8	6

Alzata torta 3 piani

3-tier cake stand
Présentoir à gâteau 3 étages
Kuchenständer 3-stufig
Presentación tarta 3 pisos

Acciaio Inox 18/10 - St. Steel 18/10

	ø cm	H. cm	ø in	H. in
V01 05 42 301	22/32/42	43,5	8,5/8-12,5/8-16,1/2	17,1/8



Servitore té/pasticceria

Afternoon tea stand
Stand thé/pâtisserie
Tee/Kuchenstander
Soporte para platos

Acciaio Inox 18/10 - St. Steel 18/10

	ø cm	H. cm	ø in	H. in	ø interno
V76 05 42 004	25	40	9,7/8	15,3/4	21,8
V76 05 42 005	30,6	42	12	16,1/2	18,3

**Alzata pasticceria**

Petit four stand
Support à pâtisserie
Petits-Fours-Ständer
Presentación pastelería

Acciaio Inox 18/10 - St. Steel 18/10

	ø cm	H. cm	ø in	H. in
V01 05 41 012	12	11	4,3/4	4,3/8
V01 05 41 016	16	11,5	6,1/4	4,1/2
V01 05 41 022	22	12	8,5/8	4,3/4

**Alzata pasticceria 2 piani**

2-tier petit four stand
Support à pâtisserie à 2 étages
Petits-fours ständer 2-stufig
Presentación pastelería 2 pisos

Acciaio Inox 18/10 - St. Steel 18/10

	ø cm	H. cm	ø in	H. in
V01 05 41 201	12/16	21,5	4,3/4-6,1/4	8,1/2
V01 05 41 202	16/22	22,5	6,1/4-8,5/8	8,7/8

**Alzata pasticceria 3 piani**

3-tier petit four stand
Support à pâtisserie à 3 étages
Kuchenständer 3-stufig
Presentación pastelería 3 pisos

Acciaio Inox 18/10 - St. Steel 18/10

	ø cm	H. cm	ø in	H. in
V01 05 41 301	12/16/22	31	4,3/4-6,1/4-8,5/8	12,1/4



Piatto torta con coperchio a bascula

Cake tray with roll top cover

Plateau à gâteaux avec cloche basculante

Kuchenplatte mit Rolltophaube

Plato para tartas con campana roll top

Acciaio Inox 18/10 - St. Steel 18/10

	ø cm	ø in
V76 05 42 003	38	15

Coperchio a bascula tondo trasparente

Transparent round rolltop cover

Cloche basculante ronde transparente

Rolltophaube - rund

Campana redonda transparente

SAN

	ø cm	ø in
V76 12 15 T01	34	13,3/8

Alzata torta con coperchio a bascula

Cake stand with roll top cover

Présentoir à gâteaux avec cloche basculante

Kuchenplatte mit Schaukeldeckel

Soporte para tartas con campana roll top

Acciaio Inox 18/10 - St. Steel 18/10

	ø cm	H. cm	ø in	H. in
V76 05 42 002	38	12,5+32	15	4,7/8 + 12,5/8





Vassoio da banco/bar pasticceria

Bar/pastry tray
Plateau bar/pâtisserie
Konditoreiplatte
Bandeja bar/pastelería

Acciaio inox 18/10 - St. steel 18/10

Vassoi adatti a banchi di pasticceria, bar e gastronomia con angolo parete chiuso. Facili da pulire ed igienici.

Trays for pastry, bar & gastronomy counters with closed corners. hygienic and Easy to clean.

FINITURE DISPONIBILI - AVAILABLE FINISHES

● ACCIAIO INOX 18/10
ST. STEEL 18/10

● PVD ORO
PVD GOLD

● VINTAGE
VINTAGE

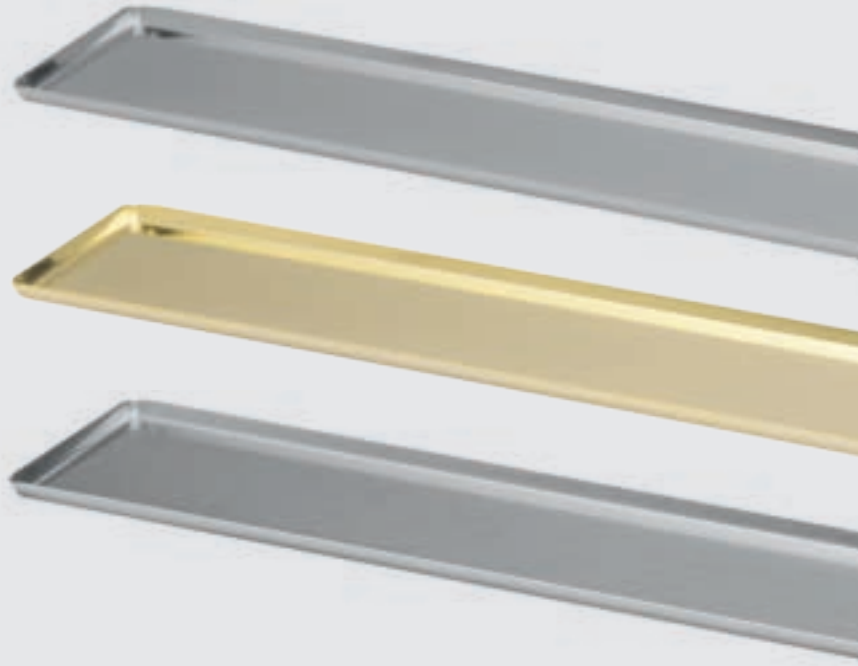

● Acciaio inox 18/10 - St. steel 18/10

	cm	H. cm	in	H. in
V01 05 23 P01	50x10	0,8	19,3/4x4	0,31

● PVD Oro - PVD Gold V01 41 23 P01

● Vintage V01 51 23 P01



● Acciaio inox 18/10 - St. steel 18/10

	cm	H. cm	in	H. in
V01 05 23 P06	35x10	0,8	13.3/4x4	0,31

● PVD Oro - PVD Gold V01 41 23 P06

● Vintage V01 51 23 P06



● Acciaio inox 18/10 - St. steel 18/10

	cm	H. cm	in	H. in
V01 05 23 P02	60x10	0,8	23.5/8x4	0,31

● PVD Oro - PVD Gold V01 41 23 P02

● Vintage V01 51 23 P02



● Acciaio inox 18/10 - St. steel 18/10

	cm	H. cm	in	H. in
V01 05 23 P07	25x20	0,8	9.7/8x7.7/8	0,31

● PVD Oro - PVD Gold V01 41 23 P07

● Vintage V01 51 23 P07

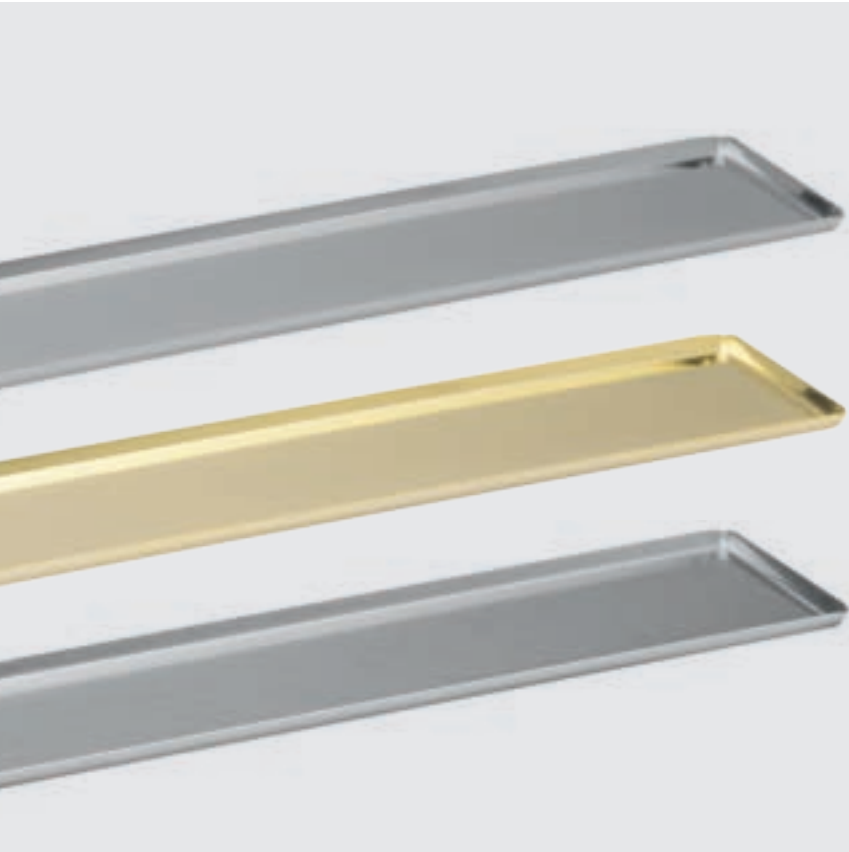

● ACCIAIO INOX 18/10
ST. STEEL 18/10

● PVD ORO
PVD GOLD

● VINTAGE
VINTAGE

FINITURE DISPONIBILI - AVAILABLE FINISHES



● Acciaio inox 18/10 - St. steel 18/10

	cm	H. cm	in	H. in
V01 05 23 P08	35x20	0,8	13.3/4x7.7/8	0,31

● PVD Oro - PVD Gold V01 41 23 P08

● Vintage V01 51 23 P08



● Acciaio inox 18/10 - St. steel 18/10

	cm	H. cm	in	H. in
V01 05 23 P03	50x20	0,8	19.3/4x7.7/8	0,31

● PVD Oro - PVD Gold V01 41 23 P03

● Vintage V01 51 23 P03



● Acciaio inox 18/10 - St. steel 18/10

	cm	H. cm	in	H. in
V01 05 23 P04	60x20	0,8	23.5/8x7.7/8	0,31

● PVD Oro - PVD Gold V01 41 23 P04

● Vintage V01 51 23 P04



● Acciaio inox 18/10 - St. steel 18/10

	cm	H. cm	in	H. in
V01 05 23 P05	70x20	0,8	27.1/2x7.7/8	0,31

● PVD Oro - PVD Gold V01 41 23 P05

● Vintage V01 51 23 P05

Molla pane Lux

Lux bread tongs
 Pince à pain Lux
 Lux Brotzange
 Pinzas pan Lux

Acciaio Inox 18/10 - St. Steel 18/10

	mm	in
9030581007	210	8,1/4

PVD Oro - PVD Gold

	mm	in
9034181007	210	8,1/4

**Molla pasticceria Lux**

Lux pastry tongs
 Pince à gâteau Lux
 Lux Gebäckzange
 Pinza para pastelería Lux

Acciaio Inox 18/10 - St. Steel 18/10

	mm	in
9030581004	210	8,1/4

PVD Oro - PVD Gold

	mm	in
9034181004	210	8,1/4

**Molla ghiaccio/zucchero Lux**

Lux ice/sugar tongs
 Pince à glace/sucre Lux
 Lux Eiszange/Zuckerzange
 Pinzas hielo/azúcar Lux

Acciaio Inox 18/10 - St. Steel 18/10

	mm	in
9030581001	126	4,7/8



Forbici servire pane Lux

Lux bread serving scissors tongs
 Pince ciseaux à servir pain Lux
 Pinzas tijeras para servir pan Lux
 Lux Brot Servierzange

Acciaio Inox 18/10 - St. Steel 18/10

	mm	in
9030581FPA	250	8,7/8

PVD Oro - PVD Gold

	mm	in
9934181FPA	250	8,7/8

**Forbici servire pasticceria Lux**

Lux pastry serving scissors
 Ciseaux à servir gâteau Lux
 Tijeras para servir pastelería Lux
 Lux gebäck-Servierzange

Acciaio Inox 18/10 - St. Steel 18/10

	mm	in
9030581FPS	210	8,1/4

PVD Oro - PVD Gold

	mm	in
9034181FPS	210	8,1/4

**Pala torta Milord**

Milord cake server
 Pelle à gâteaux Milord
 Milord Tortenheber
 Pala pastel Milord

Acciaio Inox 18/10 - St. Steel 18/10

	mm	in
C1439	240	9,1/2

PVD Oro - PVD Gold

	mm	in
C144139	240	9,1/2



Vaso in vetro con coperchio

Glass jar with lid
Pot en verre avec couvercle
Jarrón de vidrio con tapa
Glasdose mit Deckel

Vetro - Glass

	Ø cm	Ø in	H. cm	H. in
4041031304	14	5,1/2	17,5	6,7/8
4041031305	14	5,1/2	23	9
4041031306	14	5,1/2	29,5	11,5/8



Vassoio con 3 porta bustine zucchero/te

Tray with 3 packed sugar/tea holders
Plateau avec 3 conteneurs sachets de sucre/té
Bandeja con 3 portasobres de azúcar/tè
Tablett mit 3 Behältern für Zucker/Tee

Acciaio Inox 18/10 - St. Steel 18/10

	cm	in	H. cm	H. in
V78 05 23 001	21,5x11	8,1/2x4,3/8	4	1,5/8



Portabustine zucchero/tè

Packed sugar/tea holder
Conteneur sachets de sucre/té
Zucker und-Teebeutel Behälter
Portasobres de azúcar/tè

Acciaio Inox 18/10 - St. Steel 18/10

	cm	in	H. cm	H. in
V78 05 04 PBU	10x6,5	3,7/8x2,1/2	3,5	1,3/8



Portatovaglioli Square

Square napkin holder
Porte-serviettes Square
Square Serviettenhalter
Servilletero Square

Acciaio Inox 18/10 - St. Steel 18/10

	cm	in	H. cm	H. in
V76 05 71 001	11x4	4,3/8x1,2/3	2	3,1/8



Portabrioche Domino da banco

Domino countertop croissants display case
 Vitrine à viennoiserie Domino de comptoir
 Expositor de pastelería Domino para mostrador
 Domino Vitrine für Croissants

Acciaio 18/10 - St.Steel**Acciaio Verniciato - Varnished steel****SAN**

	cm	in	H. cm	H. in
V33 18 52 052	48x32	18,7/8x12,5/8	17	6,3/4

**Portabrioche Domino rialzato**

Domino croissants display case with stand
 Vitrine à viennoiserie Domino avec support
 Expositor de pastelería Domino con soporte
 Domino-Croissant-Vitrine mit Ständer

Acciaio 18/10 - St.Steel**Acciaio Verniciato - Varnished steel****SAN**

	cm	in	H. cm	H. in
V33 18 52 051	48x32	18,7/8x12,5/8	37	14,5/83,1/2



Jambee

Jambee
Jambee
Jambee
Jambee

Acciaio Inox 18/10 - St. Steel 18/10

	lt	oz	cm	in
V77 0552 DMB	0,7	24	12,5x34,5 H Min 44,5 H Max 58	5x13,5/8 H Min 17,1/2 H Max 22,7/8
V77 0552 DMC	1	35	12,5x34,5 H Min 48 H Max 71,5	5x13,5/8 H Min 18,3/4 H Max 28,1/8

Erogatore a siringa

Syringe nozzle
Embout seringue
Ausgieberspritze
Boquilla jeringa

Acciaio Inox 18/10 - St. Steel 18/10

Z77 4652 DMA

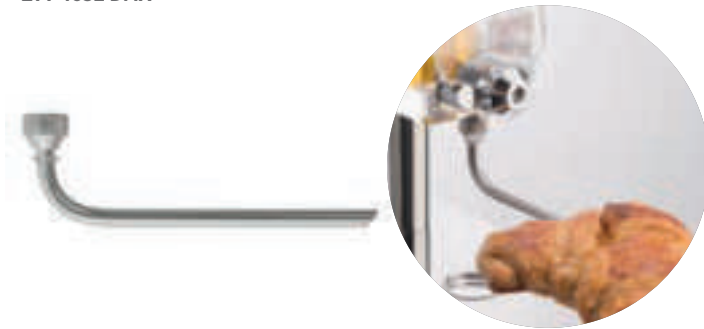

Alzata presentazione bianca Domino

Domino podium, white
 Présentoir Domino blanc
 Domino Podium, weiß
 Soporte presentación Domino blanco

Acciaio Verniciato - Varnished Steel

	cm	H. cm	in	H. in
V331842030	20x40	9	7,7/8x15,3/4	3,1/2

**Alzata presentazione bianca Domino**

Domino podium, white
 Présentoir Domino blanc
 Domino Podium, weiß
 Soporte presentación Domino blanco

Acciaio Verniciato - Varnished Steel

	cm	H. cm	in	H. in
V331842031	20x40	20	7,7/8x15,3/4	7,7/8

**Alzata presentazione bianca Domino**

Domino podium, white
 Présentoir Domino blanc
 Domino Podium, weiß
 Soporte presentación Domino blanco

Acciaio Verniciato - Varnished Steel

	cm	H. cm	in	H. in
V331842032	20x60	9	7,7/8x23,5/8	3,1/2

**Alzata presentazione bianca Domino**

Domino podium, white
 Présentoir Domino blanc
 Domino Podium, weiß
 Soporte presentación Domino blanco

Acciaio Verniciato - Varnished Steel

	cm	H. cm	in	H. in
V331842033	20x60	20	7,7/8x23,5/8	7,7/8



Gres Blue mix

	cm	in
V332142003	20x20	7,7/8x7,7/8

**Gres Yellow mix**

	cm	in
V332142006	20x20	7,7/8x7,7/8

**Gres Grey mix**

	cm	in
V332142001	20x20	7,7/8x7,7/8

**Gres Light Grey**

	cm	in
V332142004	20x20	7,7/8x7,7/8



Portabrioche singolo

Croissant tray

Plateau porte-croissants

Brot Büfettkorb

Bandeja de buffet

base pp - coperchio san**tray pp - lid san**

	cm	in	H. cm	H. in
V77 12 52 01P	50x30,5	19,5/8x12,1/8	18,5	7,1/4
V77 12 52 03P	40x24,5	15,3x9,5/8	15,5	6,1/8

**Portabrioche doppio**

Double-deck croissant tray

Porte-croissants deux étages

Doppelsplatte Brot Büfettkorb

Bandeja de buffet con dos pisos

base pp - coperchio san**tray pp - lid san**

	cm	in	H. cm	H. in
V77 12 52 02P	50x30,5	19,5/8x12,1/8	39	15,3/8

**Portabrioche tondo**

Round croissant tray

Porte-croissants rond

Brot Büfettkorb rund

Bandeja de buffet redonda

base pp - coperchio san**tray pp - lid san**

	ø cm	ø in
V77 12 52 0TP	46	18,1/8
V77 12 52 0TP1	38	15



Portaformaggi/affettati refrigerato singolo

Thermal food tray rectangular
 Porte-dîner rectangulaire réfrigérant individuel
 Wurstwarenplatte, rechteckig
 Bandeja portquesos/embutidos rectangular refrigerante individual

base pp - coperchio san
tray pp - lid san

	cm	in	H. cm	H. in
V77 12 54 01P	50x30,5	19,5/8x12,1/8	18,5	7,1/4

**Portaformaggi/affettati refrigerato doppio**

Thermal food tray rectangular, double
 Porte-dîner rectangulaire réfrigérant double
 Doppelwurstwarenplatte, rechteckig
 Bandeja portquesos rectangular refrigerante doble

base pp - coperchio san
tray pp - lid san

	cm	in	H. cm	H. in
V77 12 54 02P	50x30,5	19,5/8x12,1/8	39	15,3/8

**Eutettici rettangolari**

Ice packs
 Blocs réfrigérants
 Kühllakkus
 Acumuladores de frío rectangulares

V77 12 95 G00

**Base coprieutettici per portaformaggi refrigerato**

Ice pack cover for termale rectangular cheese dish
 Base couvre blocs réfrigérants pour porte-dimer réfrigérant
 Kühllakkus scheinbe für Wurstwaremplate, rechteckig
 Base para acumuladores de frío para bandeja portquesos refrigerante

Acciaio Inox 18/10 - St. Steel 18/10

	cm	in
Z77 19 54 01P	43,5x24	17,1/8x9,1/2

BUFFET

BUFFET

COSMO





Crostatina
di
Ciocco
Guanaja

Distributore caffè Cosmo

Cosmo coffee urn
 Distributeur de café Cosmo
 Cosmo, Kaffeespender
 Dispensador de café Cosmo

	lt	H. cm	H. in
V333252002	7	44	17,3/8
V333252003	10	51	20,1/8

**Distributore succhi Cosmo**

Cosmo juice dispenser
 Distributeur de jus Cosmo
 Cosmo, Saftspender
 Dispensador de zumos Cosmo

	lt	H. cm	H. in
V333252001	8	56	22

**Base salvagocchia con griglia Cosmo**

Cosmo drip-tray with grill
 Base anti-gouttes avec grille Cosmo
 Cosmo, Tropfschale mit Grill
 Base salvagotas con rejilla Cosmo
***con calamita - with magnet**

Acciaio 18/10 - St. Steel

	cm	in
Z339952001	16x16	6,1/4x6,1/4



Distributore cereali singolo Cosmo

Cosmo individual cereal dispenser
 Distributeur à cereales individuel Cosmo
 Cosmo, Cerealienspender
 Dispensador cereales individual Cosmo

	lt	H. cm	H. in
V333252015	3	53	20,7/8

**Distributore cereali doppio Cosmo**

Cosmo double cereal dispenser
 Distributeur à cereales double Cosmo
 Cosmo, Doppel-Cerealienspender
 Dispensador cereales doble Cosmo

	lt	H. cm	H. in
V333252016	3 (x2)	53	20,7/8



Alzata torta senza coperchio Cosmo

Cosmo cake stand without cover
 Présentoir à gâteau sans cloche Cosmo
 Cosmo, Kuchenständer ohne Haube
 Presentación tarta sin tapa Cosmo

Acciaio 18/10 - St. Steel / Legno massello - Solid wood

	∅ cm	H. cm	∅ in	H. in
V333242001	38	12	15	4,3/4

**Alzata torta senza coperchio Cosmo**

Cosmo cake stand without cover
 Présentoir à gâteau sans cloche Cosmo
 Cosmo, Kuchenständer ohne Haube
 Presentación tarta sin tapa Cosmo

Acciaio 18/10 - St. Steel / Legno massello - Solid wood

	∅ cm	H. cm	∅ in	H. in
V333242002	38	17	15	6,3/4



Alzata torta con coperchio Cosmo

Cosmo cake stand with cover

Présentoir à gâteau avec cloche Cosmo

Cosmo, Kuchenständer mit Haube

Presentación tarta con tapa Cosmo

Acciaio 18/10 - St.Steel / Legno massello - Solid wood / SAN

	ø cm	H. cm	ø in	H. in
V333242010	38	31	15	12,1/4

**Alzata torta con coperchio Cosmo**

Cosmo cake stand with cover

Présentoir à gâteau avec cloche Cosmo

Cosmo, Kuchenständer mit Haube

Presentación tarta con tapa Cosmo

Acciaio 18/10 - St.Steel / Legno massello - Solid wood / SAN

	ø cm	H. cm	ø in	H. in
V333242011	38	36	15	14,1/8



Portaformaggi /affettati refrigerato rettangolare con coperchio Cosmo

Cosmo thermal cheese/cold cuts tray rectangular
 Plateau fromage/charc réfrigéré rectangulaire avec cloche Cosmo
 Cosmo, Käseplatte mit Haube, gekühlt, rechteckig
 Portaquesos/embutidos refrigerado rectangular con tapa Cosmo

Acciaio 18/10 - St. Steel / Acciaio Verniciato - Varnished steel / SAN

	cm	H. cm	in	H. in	colore / colour
V333254005	29x48	21	11,3/8x18,7/8	8,1/4	nero / black
V333254006	29x48	21	11,3/8x18,7/8	8,1/4	corten



Piatto rettangolare refrigerato Cosmo

Cosmo plate, thermal, rectangular
 Plat rectangulaire réfrigéré Cosmo
 Cosmo, Platte rechteckig, gekühlt
 Plato rectangular refrigerado Cosmo

Acciaio 18/10 - St. Steel / Acciaio Verniciato - Varnished steel

	cm	H. cm	in	H. in	colore / colour
V333254015	29x48	5,5	11,3/8x18,7/8	2,1/8	nero / black
V333254016	29x48	5,5	11,3/8x18,7/8	2,1/8	corten



Alzata per piatti refrigerati rettangolari Cosmo

Cosmo stand for rectangular refrigerated plates
 Support à assiettes rectangulaires réfrigérées Cosmo
 Cosmo Ständer für gekühlte, rechteckige Platten
 Soporte rectangular Cosmo para platos refrigerados

Acciaio Verniciato - Varnished Steel

	cm	H. cm	in	H. in	colore / colour
V331854001	44x25	17	17,3/8x9,7/8	6,3/4	nero / black
V331854002	44x25	17	17,3/8x9,7/8	6,3/4	corten



Portaformaggi /affettati refrigerato tondo con coperchio Cosmo

Cosmo thermal cheese/cold cuts tray round

Plateau fromage/charc réfrigéré rond avec cloche Cosmo

Cosmo, Käseplatte mit Haube, gekühlt, rund

Portaquesos/embutidos refrigerado redondo con tapa Cosmo

Acciaio 18/10 - St. Steel / Acciaio Verniciato - Varnished steel / SAN

	ø cm	H. cm	ø in	H. in	colore / colour
V333254001	43	29	16,7/8	11,3/8	nero / black
V333254002	43	29	16,7/8	11,3/8	corten



Piatto tondo refrigerato Cosmo

Cosmo plate, thermal, round

Plat rond réfrigéré Cosmo

Cosmo, Platte rund, gekühlt

Plato redondo refrigerado Cosmo

Acciaio 18/10 - St. Steel / Acciaio Verniciato - Varnished steel

	ø cm	H. cm	ø in	H. in	colore / colour
V333254011	43	5,5	16,7/8	2,1/8	nero / black
V333254012	43	5,5	16,7/8	2,1/8	corten

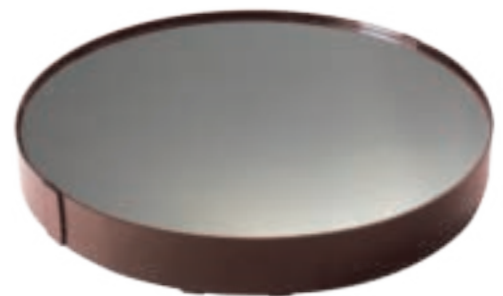

Alzata buffet Cosmo

Cosmo buffet stand
Support à buffet Cosmo
Cosmo Buffetständer
Soporte buffet Cosmo

Acciaio Verniciato - Varnished Steel

	H. cm	H. in
V331842001	20	7,7/8
V331842002	25	9,7/8
V331842003	30	11,3/4

**Fornelletto per bisticchiera Cosmo**

Burner for Cosmo grill pan
Réchaud pour grill Cosmo
Réchaud für Grillpfanne Cosmo
Hornillo para parrilla Cosmo

Acciaio 18/10 - St. Steel / Acciaio Verniciato - Varnished steel

	H. cm	H. in
V333252010	21	8,1/4

**Ciotola/bastardella**

Bowl
Bol
Schüssel
Bol

Inox 18/10 - St. Steel

	ø cm	ø in
AVARI050	20	7,7/8
AVARI053	23	9
AVARI051	26	10,1/4
AVARI054	29	11,3/8

**Base tonda nero opaco**

Base, round, matte black
Base ronde noir mat
Basis, rund, matt schwarz
Base redonda negro mate

Legno Massello - Solid Wood

	ø cm	ø in
Z331952001	18,7	7,1/4





Cestino pane tondo con bascula Cosmo

Cosmo bread basket with rolltop cover, round
 Corbeille à pain rond avec cloche bascul Cosmo
 Cosmo, Brotkorb rund mit Rollhaube
 Cesta pan redonda con tapa roll-top Cosmo

Acciaio Verniciato - Varnished Steel / Juta / SAN

	ø cm	H. cm	ø in	H. in
V333224010	36	35	14,1/8	13,3/4



Cestino pane rettangolare con bascula Cosmo

Cosmo bread basket with rolltop cover, rectangular
 Corbeille à pain rectangulaire avec cloche bascul Cosmo
 Cosmo, Brotkorb rechteckig mit Rollhaube
 Cesta pan rectangular con tapa roll-top Cosmo

Acciaio Verniciato - Varnished Steel / Juta / SAN

	cm	H. cm	in	H. in
V333224011	36x21	28	14,1/8x8,1/4	11



Forbici servire pasticceria Lux

Lux pastry serving scissors
 Ciseaux à servir gâteau Lux
 Tijeras para servir pastelería Lux
 Lux Gebäck-Servierzange

Acciaio Inox 18/10 - St. Steel 18/10

	mm	in
9030581FPS	210	8,1/4



Forbici servire pane Lux

Lux bread serving scissors tongs
 Pince ciseaux à servir pain Lux
 Pinzas tijeras para servir pan Brot Lux
 Lux Servierzange

Acciaio Inox 18/10 - St. Steel 18/10

	mm	in
9030581FPA	250	8,7/8









Scaldavivande tondo Cosmo, acciaio

Cosmo round chafing dish, St. Steel
 Chafing dish rond Cosmo acier
 Chafing dish redondo Cosmo acero
 Cosmo chafing dish, rund, Edelstahl

Acciaio 18/10 - St. Steel

	Interno / Inside ø cm	H. cm
V33 05 52 T01	30	13,5



Scaldavivande tondo Cosmo, copper

Cosmo round chafing dish, copper
 Chafing dish rond Cosmo copper
 Chafing dish redondo Cosmo copper
 Cosmo chafing dish, rund, Kupfer

Acciaio 18/10 - St. Steel

	Interno / Inside ø cm	H. cm
V33 40 52 T01	30	13,5



Scaldavivande tondo Cosmo, nero

Cosmo round chafing dish, black
 Chafing dish rond Cosmo black
 Chafing dish redondo Cosmo black
 Cosmo chafing dish, rund, schwarz

Acciaio 18/10 - St. Steel

	Interno / Inside ø cm	H. cm
V33 63 52 T01	30	13,5



Bacinella per scaldavivande Cosmo

Food pan for Cosmo chafing dish
 Bac pour chafing dish Cosmo
 Cubeta para chafing dish Cosmo
 Speiseschale für chafing dish Cosmo

Acciaio 18/10 - St. Steel

	Interno / Inside ø cm	H. cm
V33 05 72 T11	12	8

**Bacinella per scaldavivande Cosmo**

Food pan for Cosmo chafing dish
 Bac pour chafing dish Cosmo
 Cubeta para chafing dish Cosmo
 Speiseschale für chafing dish Cosmo

Acciaio Inox Smaltato - Enamelled St. Steel

	Interno / Inside ø cm	H. cm
V33 05 72 T12	12	8

**Bacinella per scaldavivande Cosmo**

Food pan for Cosmo chafing dish
 Bac pour chafing dish Cosmo
 Cubeta para chafing dish Cosmo
 Speiseschale für chafing dish Cosmo

Acciaio Inox 18/10 - 18/10 St. Steel

	Interno / Inside ø cm	H. cm
V33 05 72 T01	30	8

**Bacinella per scaldavivande Cosmo**

Food pan for Cosmo chafing dish
 Bac pour chafing dish Cosmo
 Cubeta para chafing dish Cosmo
 Speiseschale für chafing dish Cosmo

Acciaio Inox Smaltato - Enamelled St. Steel

	Interno / Inside ø cm	H. cm
V33 05 72 T02	30	8



Supporto in legno con piastra a induzione

Wooden stand Life + Induction plate
 Support bois + Plaque à induction
 Soporte madera + Placa de inducción
 Holzständer + Induktionsplatte

Noce - Nut

	cm	H. cm	in	H. in
V33 04 52 001	32 x 38	8	12,5/8 x 15	3,1/8



Supporto in legno con piastra a induzione

Wooden stand Life + Induction plate
 Support bois + Plaque à induction
 Soporte madera + Placa de inducción
 Holzständer + Induktionsplatte

Nero - Black

	cm	H. cm	in	H. in
V33 04 52 002	32 x 38	8	12,5/8 x 15	3,1/8

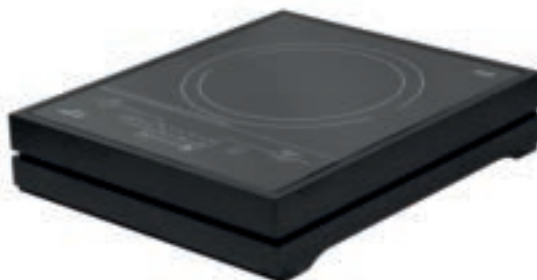

Supporto piastra legno

Wooden stand
 Support bois
 Soporte madera
 Holzständer

Noce - Nut

	cm	H. cm	in	H. in
Z33 25 52 010	32 x 38	8	12,5/8 x 15	3,1/8

Nero - Black

	cm	H. cm	in	H. in
Z33 25 52 010	32 x 38	8	12,5/8 x 15	3,1/8





Scaldavivande Cosmo GN 2/3 con telaio acciaio

Cosmo chafing-dish, GN 2/3 with steel support
Chafing dish Cosmo GN 2/3 avec support en acier
Chafing dish Cosmo GN 2/3 con soporte en acero
Cosmo, Chafing dish, GN 2/3 mit Stahlauflage

Acciaio Inox 18/10 - St. Steel 18/10

V330552001



Scaldavivande Cosmo GN 2/3 per induzione con telaio acciaio

Cosmo chafing-dish, GN 2/3, induction with steel support
Chafing dish Cosmo GN 2/3 induction avec support en acier
Chafing dish Cosmo GN 2/3 inducción con soporte en acero
Cosmo, Chafing dish, Induktion, GN 2/3 mit Stahlauflage

Acciaio Inox 18/10 - St. Steel 18/10

V330552007



Scaldavivande Cosmo GN 2/3 con telaio nero

Cosmo chafing-dish, GN 2/3 with black support
 Chafing dish Cosmo GN 2/3 avec support noir
 Chafing dish Cosmo GN 2/3 con soporte negro
 Cosmo, Chafing dish, GN 2/3 mit schwarzer Auflage

Acciaio Inox 18/10 - St. Steel 18/10

V331852001

**Scaldavivande Cosmo GN 2/3 per induzione con telaio nero**

Cosmo chafing-dish, GN 2/3, induction, with steel support
 Chafing dish Cosmo GN 2/3 induction avec support noir
 Chafing dish Cosmo GN 2/3 inducción con soporte negro
 Cosmo, Chafing dish, Induktion, GN 2/3 mit schwarzer Auflage

Acciaio Inox 18/10 - St. Steel 18/10

V331852007



DOMINO





Alzata presentazione corten Domino

Domino podium, corten
 Présentoir Domino corten
 Domino Podium, corton
 Soporte presentación Domino corten

Acciaio Verniciato - Varnished Steel

	cm	H. cm	in	H. in
V331842020	20x40	9	7,7/8x15,3/4	3,1/2



Alzata presentazione corten Domino

Domino podium, corten
 Présentoir Domino corten
 Domino Podium, corton
 Soporte presentación Domino corten

Acciaio Verniciato - Varnished Steel

	cm	H. cm	in	H. in
V331842021	20x40	20	7,7/8x15,3/4	7,7/8



Alzata presentazione corten Domino

Domino podium, corten
 Présentoir Domino corten
 Domino Podium, corton
 Soporte presentación Domino corten

Acciaio Verniciato - Varnished Steel

	cm	H. cm	in	H. in
V331842022	20x60	9	7,7/8x23,5/8	3,1/2



Alzata presentazione corten Domino

Domino podium, corten
 Présentoir Domino corten
 Domino Podium, corton
 Soporte presentación Domino corten

Acciaio Verniciato - Varnished Steel

	cm	H. cm	in	H. in
V331842023	20x60	20	7,7/8x23,5/8	7,7/8



Alzata presentazione corten Domino

Domino podium, corten
 Présentoir Domino corten
 Domino Podium, corton
 Soporte presentación Domino corten

Acciaio Verniciato - Varnished Steel

	cm	H. cm	in	H. in
V331842024	40x40	9	15,3/4x15,3/4	3,1/2



Alzata presentazione corten Domino

Domino podium, corten
 Présentoir Domino corten
 Domino Podium, corton
 Soporte presentación Domino corten

Acciaio Verniciato - Varnished Steel

	cm	H. cm	in	H. in
V331842025	40x60	9	15,3/4x23,5/8	7,7/8





Alzata presentazione nera Domino

Domino podium, black
 Présentoir Domino noir
 Domino Podium, schwarz
 Soporte presentación Domino negro

Acciaio Verniciato - Varnished Steel

	cm	H. cm	in	H. in
V331842010	20x40	9	7,7/8x15,3/4	3,1/2

**Alzata presentazione nera Domino**

Domino podium, black
 Présentoir Domino noir
 Domino Podium, schwarz
 Soporte presentación Domino negro

Acciaio Verniciato - Varnished Steel

	cm	H. cm	in	H. in
V331842011	20x40	20	7,7/8x15,3/4	7,7/8

**Alzata presentazione nera Domino**

Domino podium, black
 Présentoir Domino noir
 Domino Podium, schwarz
 Soporte presentación Domino negro

Acciaio Verniciato - Varnished Steel

	cm	H. cm	in	H. in
V331842012	20x60	9	7,7/8x23,5/8	3,1/2

**Alzata presentazione nera Domino**

Domino podium, black
 Présentoir Domino noir
 Domino Podium, schwarz
 Soporte presentación Domino negro

Acciaio Verniciato - Varnished Steel

	cm	H. cm	in	H. in
V331842013	20x60	20	7,7/8x23,5/8	7,7/8

**Alzata presentazione nera Domino**

Domino podium, black
 Présentoir Domino noir
 Domino Podium, schwarz
 Soporte presentación Domino negro

Acciaio Verniciato - Varnished Steel

	cm	H. cm	in	H. in
V331842014	40x40	9	15,3/4x15,3/4	3,1/2

**Alzata presentazione nera Domino**

Domino podium, black
 Présentoir Domino noir
 Domino Podium, schwarz
 Soporte presentación Domino negro

Acciaio Verniciato - Varnished Steel

	cm	H. cm	in	H. in
V331842015	40x60	9	15,3/4x23,5/8	7,7/8





Alzata presentazione bianca Domino

Domino podium, white
 Présentoir Domino blanc
 Domino Podium, weiß
 Soporte presentación Domino blanco

Acciaio Verniciato - Varnished Steel

	cm	H. cm	in	H. in
V331842030	20x40	9	7,7/8x15,3/4	3,1/2

**Alzata presentazione bianca Domino**

Domino podium, white
 Présentoir Domino blanc
 Domino Podium, weiß
 Soporte presentación Domino blanco

Acciaio Verniciato - Varnished Steel

	cm	H. cm	in	H. in
V331842031	20x40	20	7,7/8x15,3/4	7,7/8

**Alzata presentazione bianca Domino**

Domino podium, white
 Présentoir Domino blanc
 Domino Podium, weiß
 Soporte presentación Domino blanco

Acciaio Verniciato - Varnished Steel

	cm	H. cm	in	H. in
V331842032	20x60	9	7,7/8x23,5/8	3,1/2

**Alzata presentazione bianca Domino**

Domino podium, white
 Présentoir Domino blanc
 Domino Podium, weiß
 Soporte presentación Domino blanco

Acciaio Verniciato - Varnished Steel

	cm	H. cm	in	H. in
V331842033	20x60	20	7,7/8x23,5/8	7,7/8

**Alzata presentazione bianca Domino**

Domino podium, white
 Présentoir Domino blanc
 Domino Podium, weiß
 Soporte presentación Domino blanco

Acciaio Verniciato - Varnished Steel

	cm	H. cm	in	H. in
V331842034	40x40	9	15,3/4x15,3/4	3,1/2

**Alzata presentazione bianca Domino**

Domino podium, white
 Présentoir Domino blanc
 Domino Podium, weiß
 Soporte presentación Domino blanco

Acciaio Verniciato - Varnished Steel

	cm	H. cm	in	H. in
V331842035	40x60	9	15,3/4x23,5/8	7,7/8





Gres Blue mix

	cm	in
V332142003	20x20	7,7/8x7,7/8

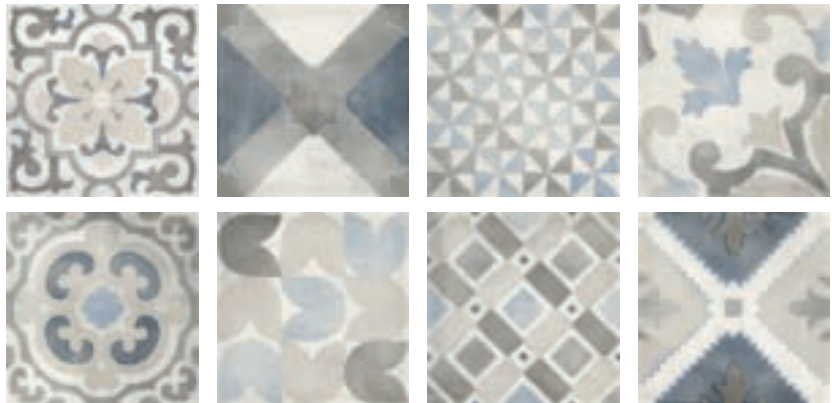

Gres Yellow mix

	cm	in
V332142006	20x20	7,7/8x7,7/8



Gres Light Grey

	cm	in
V332142004	20x20	7,7/8x7,7/8

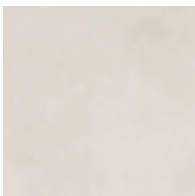

Gres Dark Grey

	cm	in
V332142005	20x20	7,7/8x7,7/8

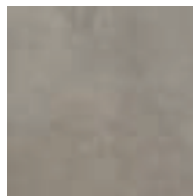

Gres Grey mix

	cm	in
V332142001	20x20	7,7/8x7,7/8

**Gres Corten mix**

	cm	in
V332142002	20x20	7,7/8x7,7/8

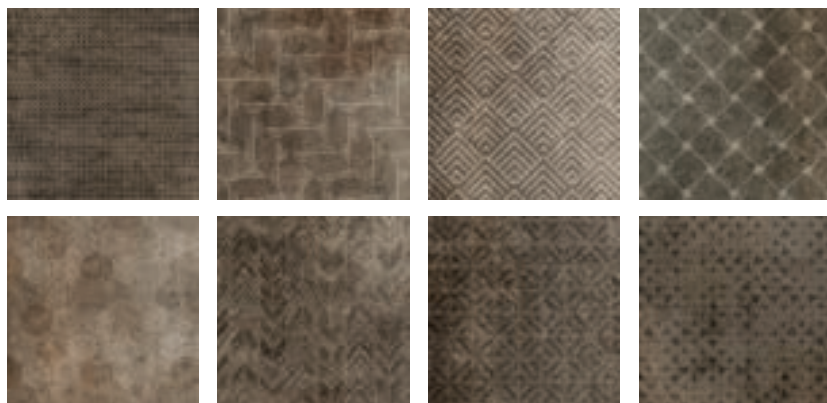
**Piatto acciaio Domino**

Domino plate, steel
Plat en acier Domino
Domino, Edelstahlplatte
Plato acero Domino

Inox 18/10 - St.Steel

	cm	in
Z332842001	40x20	15,3/4x7,7/8

**Piatto acciaio Domino**

Domino plate, steel
Plat en acier Domino
Domino, Edelstahlplatte
Plato acero Domino

Inox 18/10 - St.Steel

	cm	in
Z332842002	60x20	23,5/8x7,7/8



DOMINO





Cornice bianca Domino

Domino frame, white
Cadre blanc Domino
Domino Rahmen, weiß
Marco blanco Domino

Legno Massello - Solid Wood

	cm	H. cm	in	H. in
V330442131	20x40	5	7,7/8x15,3/4	2

**Cornice bianca Domino**

Domino frame, white
Cadre blanc Domino
Domino Rahmen, weiß
Marco blanco Domino

Legno Massello - Solid Wood

	cm	H. cm	in	H. in
V330442132	20x60	5	7,7/8x23,5/8	2

**Cornice bianca Domino**

Domino frame, white
Cadre blanc Domino
Domino Rahmen, weiß
Marco blanco Domino

Legno Massello - Solid Wood

	cm	H. cm	in	H. in
V330442133	40x40	5	15,3/4x15,3/4	2

**Cornice bianca Domino**

Domino frame, white
Cadre blanc Domino
Domino Rahmen, weiß
Marco blanco Domino

Legno Massello - Solid Wood

	cm	H. cm	in	H. in
V330442134	40x60	5	15,3/4x23,5/8	2





Cornice scura Domino

Domino frame, dark
Cadre foncé Domino
Domino Rahmen, dunkel
Marco oscuro Domino

Legno Massello - Solid Wood

	cm	H. cm	in	H. in
V330442151	20x40	5	7,7/8x15,3/4	2

**Cornice scura Domino**

Domino frame, dark
Cadre foncé Domino
Domino Rahmen, dunkel
Marco oscuro Domino

Legno Massello - Solid Wood

	cm	H. cm	in	H. in
V330442152	20x60	5	7,7/8x23,5/8	2

**Cornice scura Domino**

Domino frame, dark
Cadre foncé Domino
Domino Rahmen, dunkel
Marco oscuro Domino

Legno Massello - Solid Wood

	cm	H. cm	in	H. in
V330442153	40x40	5	15,3/4x15,3/4	2

**Cornice scura Domino**

Domino frame, dark
Cadre foncé Domino
Domino Rahmen, dunkel
Marco oscuro Domino

Legno Massello - Solid Wood

	cm	H. cm	in	H. in
V330442154	40x60	5	15,3/4x23,5/8	2







Griglia 3 caraffe Domino

Domino stand, 3-pitcher
Support pour 3 carafes Domino
Domino, Halterung für 3 Flaschen
Soporte para 3 jarras Domino

Acciaio 18/10 - St. Steel

	cm	in
Z334742001	40x20	15,3/4x7,7/8

Eutettico rettangolare

Ice pack
Bloc réfrigérant
Kühlakkus
Acumulador de frío rectangular

	cm	H. cm	in	H. in
V771295M00	17x8	2	6,3/4x3,1/8	0,3/4



Piatto acciaio Domino

Domino plate, steel
 Plat en acier Domino
 Domino, Edelstahlplatte
 Plato acero Domino

Acciaio 18/10 - St. Steel

	cm	in
Z332842001	40x20	15,3/4x7,7/8

**Piatto acciaio Domino**

Domino plate, steel
 Plat en acier Domino
 Domino, Edelstahlplatte
 Plato acero Domino

Acciaio 18/10 - St. Steel

	cm	in
Z332842002	60x20	23,5/8x7,7/8

**Copri eutettico Domino**

Domino ice-pack cover
 Couvercle bloc réfrigérant Domino
 Domino, Abdeckung Kühlpacks
 Tapa para acumulador de frío Domino

Acciaio 18/10 - St. Steel

	cm	in
Z331942001	36x16	14,1/8x6,1/4

**Copri eutettico Domino**

Domino ice-pack cover
 Couvercle bloc réfrigérant Domino
 Domino, Abdeckung Kühlpacks
 Tapa para acumulador de frío Domino

Acciaio 18/10 - St. Steel

	cm	in
Z331942002	56x16	22x6,1/4

**Bacinella porta eutettici/briciole Domino**

Domino ice-pack/crumb holder
 Cuvette blocs réfrigérants/miettes Domino
 Domino, Kühlpack- Krümelhalter
 Cubeta para acumuladores de frío/migas Domino

Alluminio - Aluminum

	cm	in
Z332042001	40x16	15,3/4x6,1/4

**Bacinella porta eutettici/briciole Domino**

Domino ice-pack/crumb holder
 Cuvette blocs réfrigérants/miettes Domino
 Domino, Kühlpack- Krümelhalter
 Cubeta para acumuladores de frío/migas Domino

Alluminio - Aluminum

	cm	in
Z332042002	60x16	23,5/8x6,1/4



Base per barattolo bianca Domino

Domino base for jar, white
 Base pour pot blanc Domino
 Domino Basis für Krug, weiß
 Base para bote blanco Domino

Legno Massello - Solid Wood

	cm	H. cm	in	H. in
V330442135	20x20	1,5	7,7/8x7,7/8	0,5/8

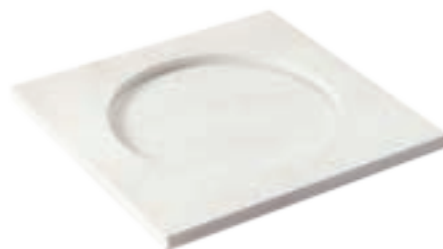
**Base per barattolo scura Domino**

Domino base for jar, dark
 Base pour pot foncé Domino
 Domino Basis für Krug, dunkel
 Base para bote oscuro Domino

Legno Massello - Solid Wood

	cm	H. cm	in	H. in
V330442155	20x20	1,5	7,7/8x7,7/8	0,5/8

**Base per bicchieri bianca Domino**

Domino base for glasses, white
 Base pour verres blanc
 Domino Basis für Weißweingläser, weiß
 Base para vasos blanco Domino

Legno Massello - Solid Wood

	cm	H. cm	in	H. in
V330442136	20x20	1,5	7,7/8x7,7/8	0,5/8

**Base per bicchieri scura Domino**

Domino base for glasses, dark
 Base pour verres foncé Domino
 Domino Basis für Weißweingläser, dunkel
 Base para vasos oscuro Domino

Legno Massello - Solid Wood

	cm	H. cm	in	H. in
V330442156	20x20	1,5	7,7/8x7,7/8	0,5/8



Vaso in vetro con coperchio

Glass jar with lid
 Pot en verre avec couvercle
 Jarrón de vidrio con tapa
 Glasdose mit Deckel

Vetro - Glass

	Ø cm	Ø in	H. cm	H. in
4041031304	14	5,1/2	17,5	6,7/8
4041031305	14	5,1/2	23	9
4041031306	14	5,1/2	29,5	11,5/8

**Bicchieri vetro basso**

Glass glass, small
 Verre bas en verre
 Glass, klein
 Vaso cristal bajo

Vetro - Glass

	Ø cm	H. cm	lt	Ø in	H. in	oz
V860842BBA	6	8	0,10	2,3/8	3,1/8	3,5

**Ciotola quadra porcellana**

Porcelain bowl
 Bol carré en porcelaine
 Porzellanschale, viereckig
 Bol cuadrado de porcellana

Porcellana - Porcelain

	cm	H. cm	in	H. in
V862142CQ7	7x7	3,5	2,3/4x2,3/4	1,3/8



Tagliere color noce Domino

Domino cutting board, walnut colour
 Planche à découper couleur noix Domino
 Domino Schneidebrett, Walnuss
 Tabla de cortar color nuez Domino

Legno massello - Solid wood

	cm	H. cm	in	H. in
V330471002	40x40	2	15,3/4x15,3/4	0,3/4

**Tagliere color noce Domino**

Domino cutting board, walnut colour
 Planche à découper couleur noix Domino
 Domino Schneidebrett, Walnuss
 Tabla de cortar color nuez Domino

Legno massello - Solid wood

	cm	H. cm	in	H. in
V330471001	20x40	2	7,7/8x15,3/4	0,3/4

**Bacinella porta eutettici/briciole Domino**

Domino ice-pack/crumb holder
 Cuvette blocs réfrigérants/miettes Domino
 Domino, Kühlpack- Krümelhalter
 Cubeta para acumuladores de frío/migas Domino

Alluminio - Aluminium

	cm	in
Z332042001	40x16	15,3/4x6,1/4

**Bacinella porta eutettici/briciole Domino**

Domino ice-pack/crumb holder
 Cuvette blocs réfrigérants/miettes Domino
 Domino, Kühlpack- Krümelhalter
 Cubeta para acumuladores de frío/migas Domino

Alluminio - Aluminium

	cm	in
Z332042002	60x16	23,5/8x6,1/4



Tagliere formaggi color noce Domino

Domino cheese cutting board, walnut colour
 Planche à découper fromages couleur noix Domino
 Domino Käsebrett, Walnuss
 Tabla de cortar quesos color nuez Domino

Legno massello - Solid wood

	cm	H. cm	in	H. in
V330471003	20x40	2	7,7/8x15,3/4	0,3/4

**Tagliere formaggi con bascula color noce Domino**

Domino cheese cutting board with rolltop cover, walnut colour
 Planche à découper fromages avec cloche couleur noix Domino
 Domino Käsebrett schwenkdeckel, Walnuss
 Tabla cortar quesos tapa rolltop color nuez Domino

Legno massello - Solid Wood / SAN

	cm	H. cm	in	H. in
V330471004	20x40	16	7,7/8x15,3/4	6,1/4

**Coltello panettone manico vuoto Lux**

Lux Panettone knife hollow handle
 Couteau panettone manche vide Lux
 Lux Panettone-Messer mit hohlem Griff
 Cuchillo panettone mango hueco Lux

Acciaio Inox - St. Steel

	cm	in
9030591MV1	28,5	11,1/4



Guarda il video
 Watch the video



Vaso in vetro con coperchio

Glass jar with lid

Pot en verre avec couvercle

Jarrón de vidrio con tapa

Glasdose mit Deckel

Vetro - Glass

	ø cm	H. cm	ø in	H. in
4041031304	14	17,5	5,1/2	6,7/8

**Base per barattolo scura Domino**

Domino base for jar, dark

Base pour pot foncé Domino

Domino Basis für Krug, dunkel

Base para bote oscuro Domino

Legno Massello - Solid Wood

	cm	H. cm	in	H. in
V330442155	20x20	1,5	7,7/8x7,7/8	0,5/8



Cornice scura Domino

Domino frame, dark
Cadre foncé Domino
Domino Rahmen, dunkel
Marco oscuro Domino

Legno Massello - Solid Wood

	cm	H. cm	in	H. in
V330442152	20x60	5	7,7/8x23,5/8	2





Caraffa acqua con coperchio basculante

Water glass pitcher with smart lid

Carafe en verre avec couvercle basculant

Wasserkaraffe

Jarra de vidrio con tapa basculante

Vetro - Glass

	lt	oz
V76 08 52 007	1	35
Grigio - Grey		
V76 08 52 007 35	1	35
Avio - Avio		
V76 08 52 007 07	1	35
Rosso - Red		



Cornice scura Domino

Domino frame, dark
Cadre foncé Domino
Domino Rahmen, dunkel
Marco oscuro Domino

Legno Massello - Solid Wood

	cm	H. cm	in	H. in
V330442152	20x60	5	7,7/8x23,5/8	2

**Bacinella porta eutettici/briciole Domino**

Domino ice-pack/crumb holder
Cuvette blocs réfrigérants/miettes Domino
Domino, Kühlpack- Krümelhalter
Cubeta para acumuladores de frío/migas Domino

Alluminio - Aluminum

	cm	in
Z332042002	60x16	23,5/8x6,1/4

**Eutettico rettangolare**

Ice pack
Bloc réfrigérant
Kühlakkus
Acumulador de frío rectangular

	cm	H. cm	in	H. in
V771295M00	17x8	2	6,3/4x3,1/8	0,3/4

**Copri eutettico Domino**

Domino ice-pack cover
Couvercle bloc réfrigérant Domino
Domino, Abdeckung Kühlpacks
Tapa para acumulador de frío Domino

Acciaio 18/10 - St. Steel

	cm	in
Z331942002	56x16	22x6,1/4

**Griglia 3 caraffe Domino**

Domino stand, 3-pitcher
Support pour 3 carafes Domino
Domino, Halterung für 3 Flaschen
Soporte para 3 jarras Domino

Acciaio 18/10 - St. Steel

	cm	in
Z334742001	40x20	15,3/4x7,7/8

**Gres Corten mix**

	cm	in
V332142002	20x20	7,7/8x7,7/8



Cornice scura Domino

Domino frame, dark
 Cadre foncé Domino
 Domino Rahmen, dunkel
 Marco oscuro Domino

Legno Massello - Solid Wood

	cm	H. cm	in	H. in
V330442152	20x60	5	7,7/8x23,5/8	2

**Bacinella porta eutettici/briciole Domino**

Domino ice-pack/crumb holder
 Cuvette blocs réfrigérants/miettes Domino
 Domino, Kühlpack- Krümelhalter
 Cubeta para acumuladores de frío/migas Domino

Alluminio - Aluminum

	cm	in
Z332042002	60x16	23,5/8x6,1/4



Tagliere color noce Domino

Domino cutting board, walnut colour
 Planche à découper couleur noix Domino
 Domino Schneidebrett, Walnuss
 Tabla de cortar color nuez Domino

Legno massello - Solid wood

	cm	H. cm	in	H. in
V330471001	20x40	2	7,7/8x15,3/4	0,3/4

**Gres Corten mix**

	cm	in
V332142002	20x20	7,7/8x7,7/8



Set pane bianco Domino

Domino bread set white
Set à pain Domino blanc
Domino, Brot Set; weiß
Set pan Domino blanco

V3332SE002



Set refrigerato bianco Domino

Domino thermal set, white
Set réfrigéré Domino blanc
Domino, Thermo Set; weiß
Set refrigerado Domino blanco

V3332SE006



Set cereali bianco Domino

Domino cereal set, white
Set à céréales Domino blanc
Domino, Cerealien Set; weiß
Set cereales Domino blanco

V3332SE004



*Per l'acquisto, far riferimento alle fotografie dei set Domino bianco.

*For purchase, please, refer to the photos of Domino white sets.

*Pour l'achat, reportez-vous aux photos des sets Domino blanc.

*Informationen zum Kauf finden Sie auf den Fotos der Domino-Sets weiß

*Para comprar, consulten las fotos de los sets Domino blanco.

Set pane scuro Domino

Domino bread set, dark
 Set à pain foncé Domino
 Domino, Brot Set; dunkel
 Set pan oscuro Domino

V3332SE001

**Set refrigerato scuro Domino**

Domino thermal set, dark
 Set réfrigéré foncé Domino
 Domino, Thermo Set; dunkel
 Set refrigerado oscuro Domino

V3332SE005

**Set cereali scuro Domino**

Domino cereal set, dark
 Set à céréales foncé Domino
 Domino, Cerealien Set; dunkel
 Set cereales oscuro Domino

V3332SE003



LIFE





Tagliere rettangolare Life, 1 manico

Cutting board, rectangular, 1-handle, Life
 Planche à découper rectangulaire 1 anse Life
 Tabla de cortar rectangular 1 asa Life
 Schneidebrett, rechteckig, 1 Griff Life

**Legno di Acacia e Ferro Brunito -
 Acacia Wood and Burnished Iron**

cm

V33 04 71 010 30 × 14

**Tagliere rettangolare Life, 2 maniglie**

Cutting board, rectangular, 2-handle, Life
 Planche à découper rectangulaire 2 anses Life
 Tabla de cortar rectangular 2 asas Life
 Schneidebrett, rechteckig, 2 Griffe Life

**Legno di Acacia e Ferro Brunito -
 Acacia Wood and Burnished Iron**

cm

V33 04 71 011 50 × 18

**Tagliere tondo Life, 1 manico**

Cutting board, round, 1-handle, Life
 Planche à découper ronde 1 anse Life
 Tabla de cortar redonda 1 asa Life
 Schneidebrett, rund, 1 Griff Life

**Legno di Acacia e Ferro Brunito -
 Acacia Wood and Burnished Iron**

ø cm

V33 04 71 012 25

**Tagliere tondo Life, 2 maniglie**

Cutting board, round, 2-handle, Life
 Planche à découper ronde 2 anses Life
 Tabla de cortar redonda 2 asas Life
 Schneidebrett, rund, 2 Griffe Life

**Legno di Acacia e Ferro Brunito -
 Acacia Wood and Burnished Iron**

ø cm

V33 04 71 013 32





Ciotola ovale Life

Bowl, oval, Life
 Bol oval Life
 Bol oval Life
 Schale, oval Life

Legno di Acacia - Acacia Wood

	cm	H. cm
V33 04 43 003	60 × 18	11,5

**Ciotola tonda Life**

Bowl, round, Life
 Bol rond Life
 Bol redondo Life
 Schale, rund Life

Legno di Acacia - Acacia Wood

	ø cm	H. cm
V33 04 43 001	26	13
V33 04 43 002	30	15

**Ciotola conica Life**

Bowl, conical, Life
 Bol conique Life
 Bol cónico Life
 Schale, konisch Life

Legno di Acacia - Acacia Wood

	ø cm	H. cm
V33 04 43 004	16	6
V33 04 43 005	23	9



Alzata tonda Life

Stand, Life
Support Life
Soporte Life
Ständer Life

Legno di Acacia - Acacia Wood

	ø cm	H. cm
V33 04 42 001	36	20

Coperchio a bascula non incluso - Round rolltop cover not included

Coperchio a bascula tondo trasparente

Transparent round rolltop cover
Cloche basculante ronde transparente
Rolltophaube - rund
Campana redonda transparente

SAN

	ø cm
V76 12 15 T01	34

**Alzata quadrata Life**

Stand, square, Life
Support carré Life
Soporte cuadrado Life
Ständer, quadratisch Life

Legno di Acacia - Acacia Wood

	cm	H. cm
V33 04 42 002	20 × 20	20
V33 04 42 003	25 × 25	15





Cassetta quadrata Life

Crate, square, Life
 Casette carrée Life
 Caja cuadrada Life
 Kiste, quadratisch Life

Legno di Acacia - Acacia Wood

	cm	H. cm
V33 04 24 001	35 × 35	5
V33 04 24 002	35 × 35	8

**Cassetta rettangolare Life**

Crate, rectangular, Life
 Casette rectangulaire Life
 Caja rectangular Life
 Kiste, rechteckig Life

Legno di Acacia - Acacia Wood

	cm	H. cm
V33 04 24 003	52,5 × 35	5
V33 04 24 004	52,5 × 35	8

**Set 2pz divisori per cassetta Life**

Divider for Life crate, 2-pc set
 Set 2 pcs séparateur pour cassette Life
 Set 2 pzs divisor para caja Life
 Trenwand für Life-Kiste, 2er-Set

Legno di Acacia - Acacia Wood

	cm	H. cm
V33 04 24 006	36	8

**Display per cassetta Life, 3 piani**

Display for Life crates, 3-tier
 Présentoir pour cassettes Life, 3 étages
 Soporte para cajas Life 3 pisos
 Display für Life-Kartons, 3-stöckig

Acciaio Verniciato Nero - Black Painted Steel

	cm	H. cm
V33 18 42 050	40 × 20	69



Ciotola black Taste

Small bowl, black, Taste
Bol petit black Taste
Bol pequeño black Taste
Kleine Schüssel, schwarz, Taste

Acciaio Inox/PTFE - Steel/PTFE

	ø cm	H. cm	ml
V33 05 43 003	11,25	3	200



Ciotola black Taste

Bowl, black, Steel/PTFE

Bol black Taste

Bol black Taste

Schüssel, schwarz, Taste

Acciaio Inox/PTFE - Steel/PTFE

	ø cm	H. cm	ml
V33 05 43 001	5,9	3	50
V33 05 43 002	7	4	130

**Ciotola conica black Taste**

Bowl, conical, black, Taste

Bol conique black Taste

Bol conico black Taste

Schüssel konisch, schwarz, Taste

Acciaio Inox/PTFE - Steel/PTFE

	ø cm	H. cm	ml
V33 05 43 004	6,5	3,5	90
V33 05 43 005	8	3,8	130

**Bicchieri black acciaio Taste**

Tumbler, black, Taste

Verre black acier Taste

Vaso black acero Taste

Vase, schwarz, Taste

Acciaio Inox/PTFE - Steel/PTFE

	ø cm	H. cm	ml
V33 05 43 006	8,5	8,5	400





Ciotola tonda Taste

Small bowl, round, Taste
 Petit bol rond en Taste
 Bol pequeño redondo Taste
 Kleine Schüssel, rund, Taste

Porcellana - Porcelain

	ø cm	Interno/Inside ø cm	H. cm
V87 21 42 006	10	3,5	3

**Ciotolina quadrata Taste**

Small bowl, square, Taste
 Petit bol carré en Taste
 Bol pequeño cuadrado Taste
 Kleine Schüssel, quadratisch, Taste

Porcellana - Porcelain

	cm	H. cm
V87 21 42 008	8 × 8	2,4

**Ciotolina a goccia Taste**

Small bowl, drop-shaped, Taste
 Petit bol en forme de goutte en Taste
 Bol pequeño en forma de lágrima Taste
 Kleine Schüssel, Tropfen-förmig, Taste

Porcellana - Porcelain

	cm	H. cm
V87 21 42 001	8 × 7	3,4

**Ciotola square Taste**

Square bowl, Taste
 Bol Square en Taste
 Bol Square Taste
 Schüssel, quadratisch, Taste

Porcellana - Porcelain

	cm	H. cm
V87 21 42 002	10 × 7,7	3,5

**Coppetta tonda Taste**

Bowl, round, small, Taste
 Petit bol rond en Taste
 Bol pequeño redondo Taste
 Schüssel, rund, Taste

Porcellana - Porcelain

	ø cm	H. cm
V87 21 42 005	6,5	3,8

**Ciotola square Taste**

Square bowl, Taste
 Bol Square en Taste
 Bol Square Taste
 Schüssel, quadratisch, Taste

Porcellana - Porcelain

	cm	H. cm
322 21 22 691	9,5 × 9,5	1,2



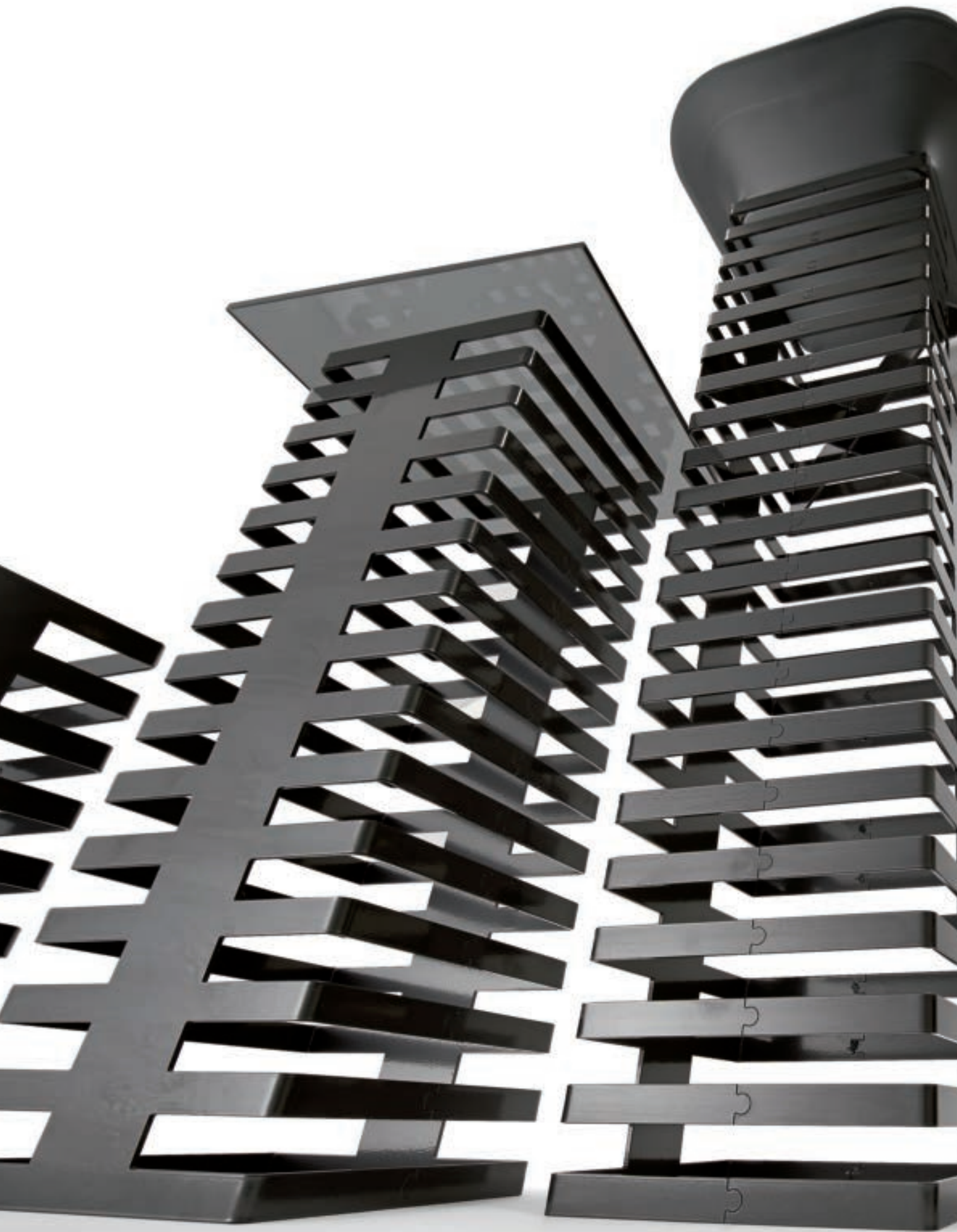

Urban

Abert firma Urban, un supporto creativo per le preparazioni in sala, versatile, fantasioso e bello da vedere.

Base ideale per un buffet di finger food, impeccabile supporto da colazione grazie ai numerosi accessori correlati e perfetto allestimento emozionale per aperitivi e brunch.

Urban è facile da allestire e consente la veloce creazione di figure geometriche modulari sempre diverse, per posizionare ogni creazione culinaria secondo la propria fantasia.

Abert has designed Urban, a creative support for food preparation in the restaurants, versatile, multipurpose and nice to see.

Ideal base for a finger-food buffet, perfect lunch podium system thanks to the numerous accessories provided, and impressive set-up for the happy hour and the brunch.

Urban is easy to assemble and allows the fast creation of continuously different modular shapes, in order to place every food preparation according to everyone's imagination.

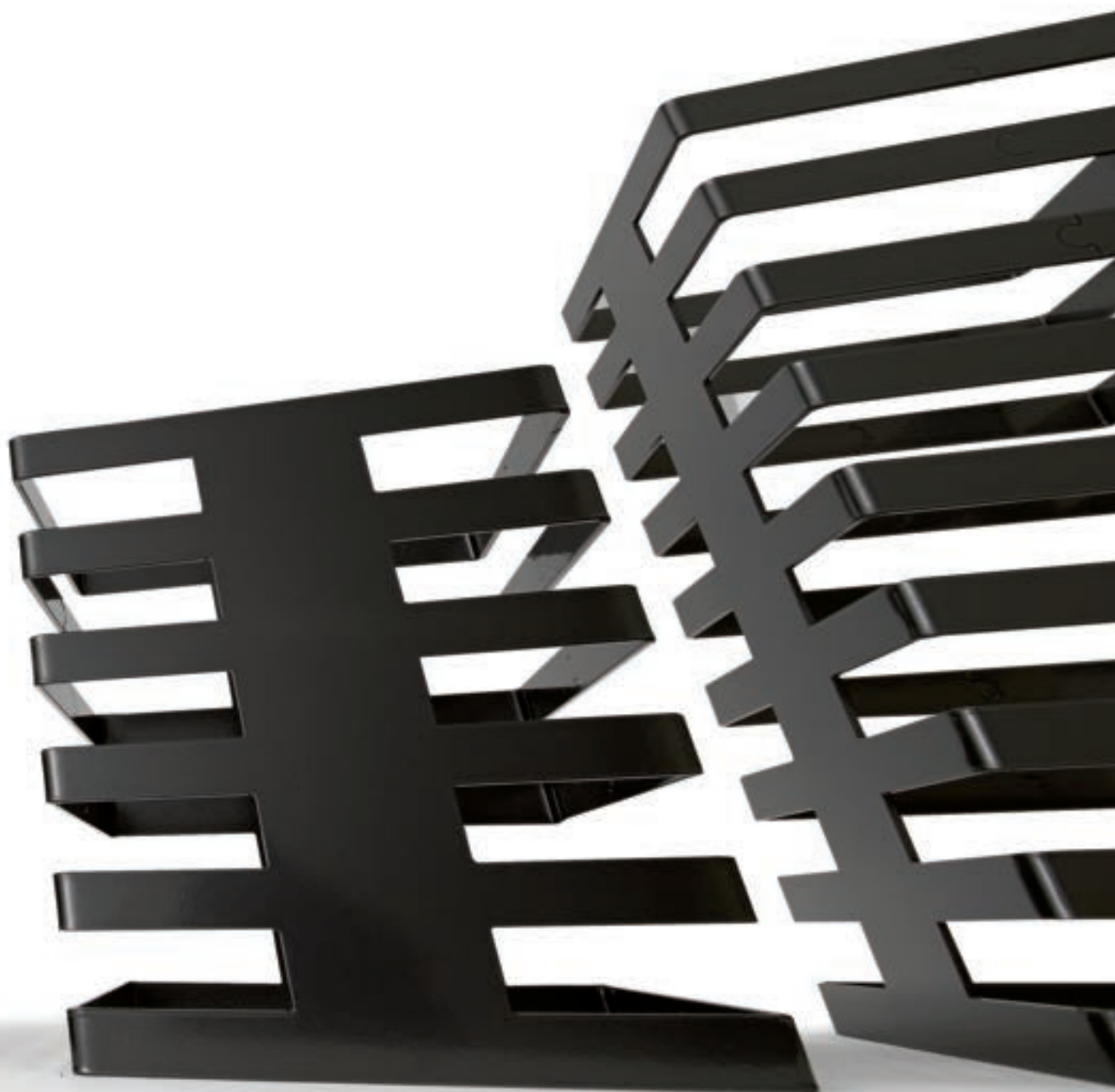



SET 1

Urban Tower
Tower Urban
Tower Urban
Urban Tower

V87 32 42 001	cm	H. cm
	140x42	67
	in	H. in
	55,1/8x16,1/2	26,3/8



SET 4

Urban Tower
Tower Urban
Tower Urban
Urban Tower

V87 32 42 004	cm	H. cm
	260x42	67
	in	H. in
	102,1/8x16,1/2	26,3/8

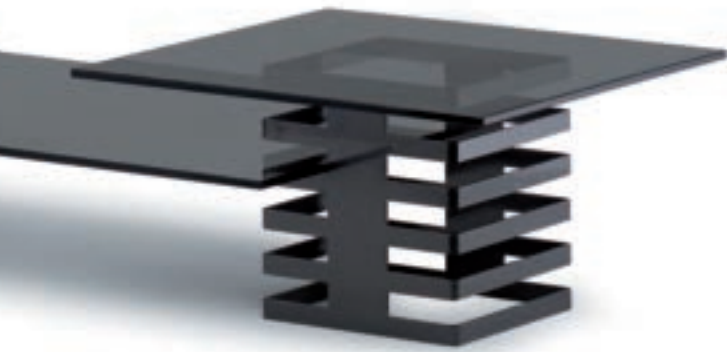

**SET 3**

Urban Tower
Tower Urban
Tower Urban
Urban Tower

V87 32 42 003

cm
150x145

H. cm
67

in

H. in

59,1/8x57,1/8

26,3/8

SET 2

Urban Tower
Tower Urban
Tower Urban
Urban Tower

V87 32 42 002

cm
140x42

H. cm
43

in

H. in

55,1/8x16,1/2

17



Tower

	cm	H. cm	in	H. in
V87 18 42 001	20x20	10	7,7/8x7,7/8	4
V87 18 42 002	20x20	22	7,7/8x7,7/8	8,5/8
V87 18 42 003	20x20	34	7,7/8x7,7/8	13,3/8
V87 18 42 004	20x20	58	7,7/8x7,7/8	22,7/8

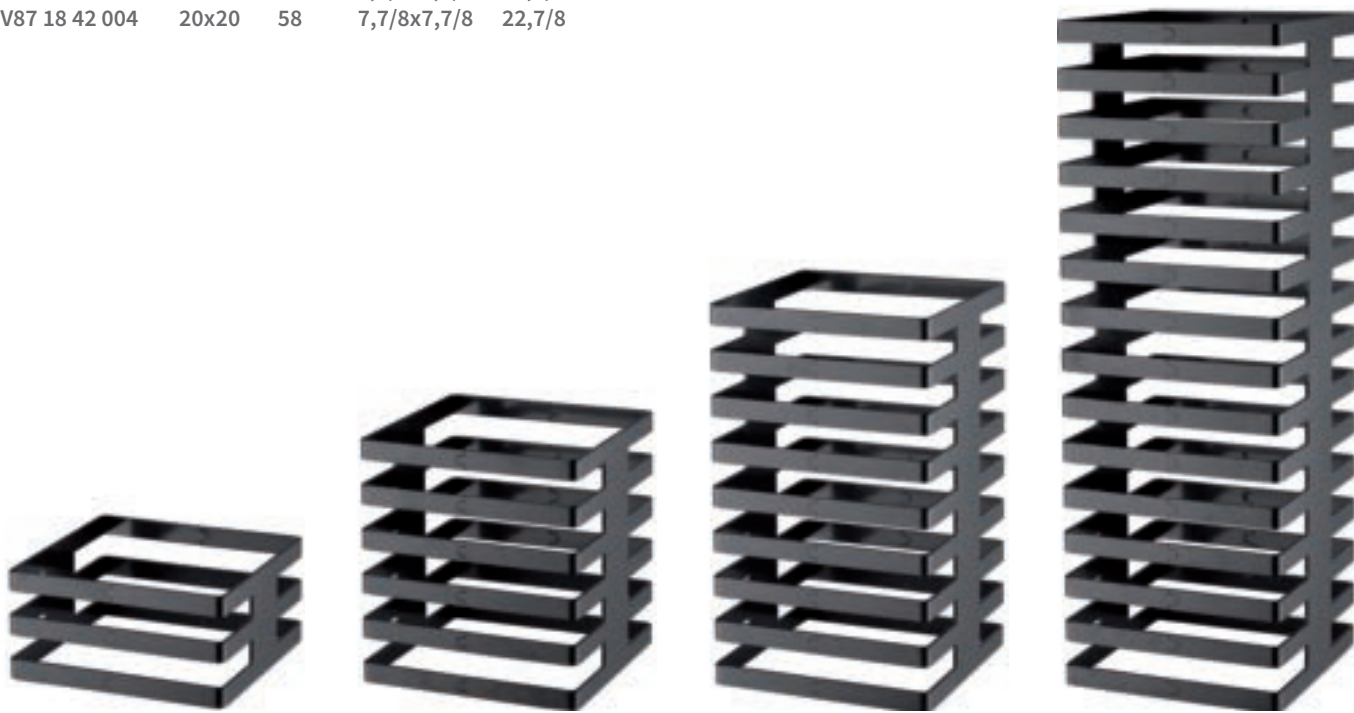

Modulo a croce

Cross-shaped extension unit
 Croix
 Verbindungskreuz
 Módulo con forma de cruz

	H. cm	in
V87 18 42 CRO	9,5	3,3/4

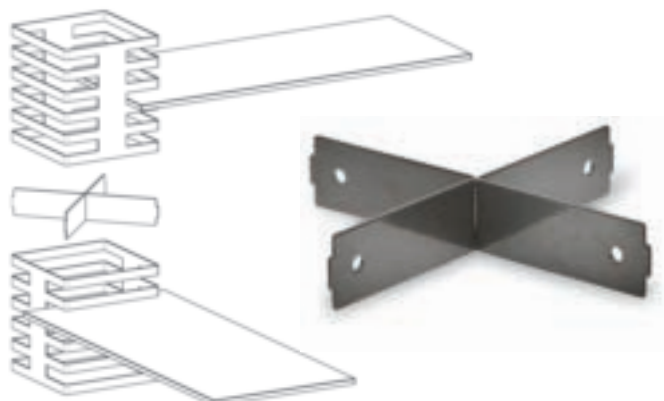

Coppa quadrata in plexiglass fumé

Smoky plexiglass salad bowl, square
 Bol plexiglass fumé carrén
 Salatschale Plexiglas viereckig Smoky
 Ensaladera acrílica fumé cuadrada

	cm	H. cm	in	H. in
V87 12 42 C01	34x34	11	13,3/8x13,3/8	4,3/8

**Piano in vetro fumé**

Smoky glass top
 Dessus en verre fumé
 Glasplatte Smoky
 Tablero de cristal fumé

	cm	in
V87 08 42 Q01	30x30	11,3/4x11,3/4
V87 08 42 Q02	42x42	16,1/2x16,1/2
V87 08 42 R01	30x70	11,3/4x27,1/2
V87 08 42 R02	30x100	11,3/4x39,3/8
V87 08 42 R03	42x70	16,1/2x27,1/2
V87 08 42 R04	42x100	16,1/2x39,3/8

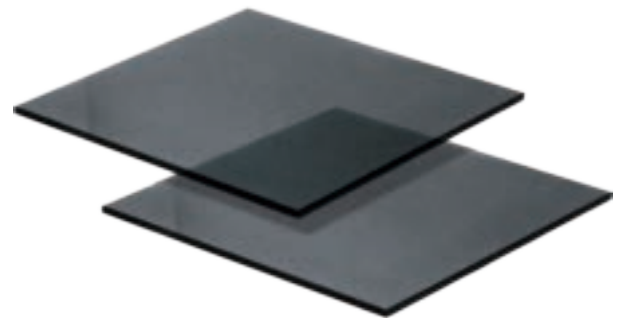
**Piano in ardesia**

Slate top
 Dessus en ardoise
 Schieferplatte
 Tablero de pizarra

	cm	in
V87 09 42 Q01	30x30	11,3/4x11,3/4
V87 09 42 Q02	42x42	16,1/2x16,1/2
V87 09 42 R01	30x70	11,3/4x27,1/2
V87 09 42 R02	30x100	11,3/4x39,3/8
V87 09 42 R03	42x70	16,1/2x27,1/2
V87 09 42 R04	42x100	16,1/2x39,3/8

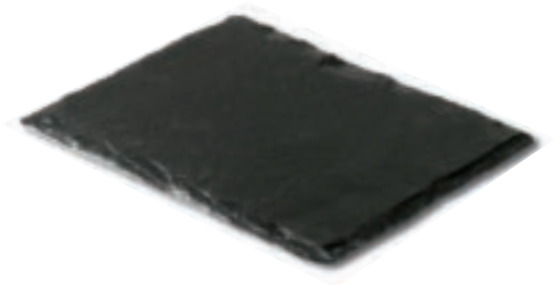
**Piano in mdf**

Mdf top
 Dessus en mdf
 Mdf Platte
 Tablero de mdf

	cm	in
V87 04 42 Q01	30x30	11,3/4x11,3/4
V87 04 42 Q02	42x42	16,1/2x16,1/2
V87 04 42 R01	30x70	11,3/4x27,1/2
V87 04 42 R02	30x100	11,3/4x39,3/8
V87 04 42 R03	42x70	16,1/2x27,1/2
V87 04 42 R04	42x100	16,1/2x39,3/8

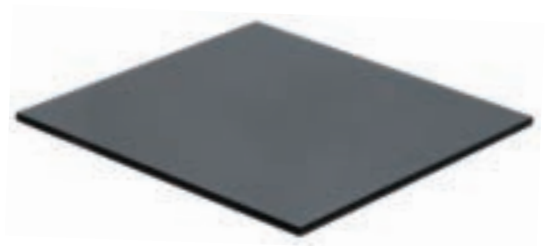

Scaldavivande da incasso con coperchio in acciaio Inox

Built-in chafing dish with St. Steel cover
Chafing dish encastrable avec couvercle en acier Inox
Chafing Dish zum Einbauen mit Edelstahl Deckel
Chafing dish para empotrar con tapa en acero Inox

Acciaio Inox 18/10 - St. Steel 18/10

	GN	cm	H. cm
V87 18 52 002	1/1	60,5x40,5	39,5
		in	H. in
		23,7/8x16	15,1/2

2 fornelletti - 2 burners



Completo di due fornelli a combustibile solido
e predisposto per piastra elettrica.
Portavivande in acciaio incluso

*With two solid fuel burners,
electric heating element available.
With Gastronorm food pan*



Scaldavivande da incasso con coperchio in acciaio Inox /vetro

Built-in chafing dish with St. Steel / glass cover
Chafing dish encastrable avec couvercle en acier Inox / verre
Chafing Dish zum Einbauen mit Edelstahl / Glass Deckel
Chafing dish para empotrar con tapa en acero Inox / vidrio

Acciaio Inox 18/10 - St. Steel 18/10

	GN	cm	H. cm
V87 18 52 003	1/1	60,5x40,5	39,5
		in	H. in
		23,7/8x16	15,1/2

2 fornelletti - 2 burners



Completo di due fornelli a combustibile solido
e predisposto per piastra elettrica
Portavivande in acciaio incluso

*With two solid fuel burners,
electric heating element available.
With GN 1/1 Gastronorm food pan*



Scaldavivande con gambe e coperchio in acciaio Inox

Chafing dish with St. Steel stand and cover
Chafing dish avec support et couvercle en acier Inox
Chafing Dish mit Beinen und Edelstahldeckel
Chafing dish con soporte y tapa en acero Inox

Acciaio Inox 18/10 - St. Steel 18/10

	GN	cm	H. cm
V87 18 52 001	1/1	63x42	31
		in	H. in
		25,3/4x16,1/2	12,1/4

2 fornelli - 2 burners

	GN	cm	H. cm
V87 18 52 004	2/3	46x42	32
		in	H. in
		18,1/8x16,1/2	12,5/8

1 fornello - 1 burner

Completo di fornello a combustibile solido e predisposto per piastra elettrica.
Portavivande in acciaio incluso

*With solid fuel burners,
electric heating element available.
With Gastronorm food pan*



Scaldavivande con gambe e coperchio acciaio Inox/vetro

Chafing dish with St. Steel/glass stand and cover
Chafing dish avec support et couvercle en acier Inox / verre
Chafing Dish mit Beinen und Edelstahl / Glasdeckel
Chafing dish con soporte y tapa en acero Inox / vidrio

Acciaio Inox 18/10 - St. Steel 18/10

	GN	cm	H. cm
V87 18 52 005	1/1	63x42	33
		in	H. in
		25,3/4x16,1/2	12,1/4

2 fornelli - 2 burners

	GN	cm	H. cm
V87 18 52 006	2/3	46x42	32
		in	H. in
		18,1/8x16,1/2	12,5/8

1 fornello - 1 burner

Completo di fornello a combustibile solido e predisposto per piastra elettrica.
Portavivande in acciaio incluso

*With solid fuel burners,
electric heating element available.
With GN 1/1 Gastronorm food pan*



Inserto GN 1/1

GN 1/1 container
 Conteneur GN 1/1
 Gn - Behälter 1/1
 Contenedor GN 1/1

Acciaio Inox 18/10 - St. Steel 18/10

	cm	H. cm	Sp. mm
V01 05 72 G11	53x32,5	2	0,7
V01 05 72 G11 B	53x32,5	6,5	0,7

**Inserto GN 2/3**

GN 2/3 container
 Conteneur GN 2/3
 Gn - Behälter 2/3
 Contenedor GN 2/3

Acciaio Inox 18/10 - St. Steel 18/10

	cm	H. cm	Sp. mm
V01 05 72 G23	35,4x32,5	2	0,7
V01 05 72 G23 B	35,4x32,5	6,5	0,7

**Inserto GN 1/3**

GN 1/3 container
 Conteneur GN 1/3
 Gn - Behälter 1/3
 Contenedor GN 1/3

Acciaio Inox 18/10 - St. Steel 18/10

	cm	H. cm	Sp. mm
V01 05 72 G13	32,5x17,6	2	0,7
V01 05 72 G13 A	32,5x17,6	4	0,7

**Inserto GN 1/2**

GN 1/2 container
 Conteneur GN 1/2
 Gn - Behälter 1/2
 Contenedor GN 1/2

Acciaio Inox 18/10 - St. Steel 18/10

	cm	H. cm	Sp. mm
V01 05 72 G12	32,5x26,5	2	0,7
V01 05 72 G12 B	32,5x26,5	6,5	0,7

**Piastra elettrica**

Electric hot plate
 Plaque électrique
 Elektrische Platte
 Placa eléctrica

Con regolatore - With regulator

V770552PCR2 Piastra elettrica con regolatore per scaldavivande 1/1 V230

**Piastra elettrica**

Electric hot plate
 Plaque électrique
 Elektrische Platte
 Placa eléctrica

Con regolatore - With regulator

V770552PCT2 Piastra elettrica con regolatore per scaldavivande 2/3 V230



Inserto GN 1/1

Food pan, GN 1/1
 Conteneur GN 1/1
 Porzellanbehälter, GN 1/1
 Contenedor GN 1/1

Porcellana - Porcelain

	H. cm	H. in
V01 21 52 G11B	6,5	2,1/2
V01 21 52 G11	2	0,3/4

**Inserto GN 2/3**

Food pan, GN 2/3
 Conteneur GN 2/3
 Porzellanbehälter, GN 2/3
 Contenedor GN 2/3

Porcellana - Porcelain

	H. cm	H. in
V01 21 52 G23B	6,5	2,1/2

**Inserto GN 1/2**

Food pan, GN 1/2
 Conteneur GN 1/2
 Porzellanbehälter, GN 1/2
 Contenedor GN 1/2

Porcellana - Porcelain

	H. cm	H. in
V01 21 52 G12B	6,5	2,1/2

**Inserto GN 1/3**

Food pan, GN 1/3
 Conteneur GN 1/3
 Porzellanbehälter, GN 1/3
 Contenedor GN 1/3

Porcellana - Porcelain

	H. cm	H. in
V01 21 52 G13B	6,5	2,1/2



Urban Organizer

Un organizer flessibile e pratico che permette di risparmiare spazio sviluppandosi in verticale come un grattacielo urbano. Fornito dei suoi accessori contenitivi di acciaio e legno permette di allestire oggetti di diverse dimensioni e soddisfare ogni esigenza. Perfetto per Buffet, Hotel e Bar.





Tower

Tower
Tower
Tower
Tower

Ferro verniciato - Varnished Iron

	H. cm	H. in
V87 18 42 002	22	8,5/8
V87 18 42 003	34	13,3/8
V87 18 42 004	58	22,7/8



Contentitore Urban Organizer

Urban Organizer container
Conteneur Urban Organizer
Urban-Organizer Holzbehälter
Contenedor Urban Organizer

Legno - Wood

	cm	in
V87 04 42 CS1	10x10x8	4x4x3,1/8



Contentitore Urban Organizer

Urban Organizer container
Conteneur Urban Organizer
Urban-Organizer Holzbehälter
Contenedor Urban Organize

Legno - Wood

	cm	in
V87 04 42 CS2	15x10x4	6x4x1,1/2



Contentitore Urban Organizer

Urban Organizer container
Conteneur Urban Organizer
Urban-Organizer Holzbehälter
Contenedor Urban Organizer

Legno - Wood

	cm	in
V87 04 42 CS3	20x15x4	7,7/8x6x1,1/2
V87 04 42 CS4	20x15x8	7,7/8x6x3,1/8



Contentitore Urban Organizer

Urban Organizer container
Conteneur Urban Organizer
Urban-Organizer Holzbehälter
Contenedor Urban Organizer

Legno - Wood

	cm	in
V87 04 42 CS5	35x17,5x4	13,3/4x6,7/8x1,1/2
V87 04 42 CS6	35x17,5x8	13,3/4x6,7/8x3,1/8



Contentitore Urban Organizer

Urban Organizer container
Conteneur Urban Organizer
Urban-Organizer Edelstahlbehälter
Contenedor Urban Organizer

Acciaio Inox 18/10 - St. Steel 18/10

	cm	in
V87 05 42 CS1	6,5x10x4	2,1/2x4x1,1/2



Contenitore Urban Organizer

Urban Organizer container
 Conteneur Urban Organizer
 Urban-Organizer Edelstahlbehälter
 Contenedor Urban Organizer

Acciaio Inox 18/10 - St. Steel 18/10

	cm	in
V87 05 42 CS2	10x6,5x4	4x2,2/1x1,1/2

**Contenitore Urban Organizer**

Urban Organizer container
 Conteneur Urban Organizer
 Urban-Organizer Edelstahlbehälter
 Contenedor Urban Organizer

Acciaio Inox 18/10 - St. Steel 18/10

	cm	in
V87 05 42 CS3	18x4,5x4	7x1,3/4 x1,1/2

**Contenitore cilindrico per anello**

Cylindrical container for ring
 Conteneur cylindrique pour anneau
 Zylindrische Edelstahlbehälter für Ring
 Contenedor cilíndrico para anillo

Inox 18/10 - St. Steel

	ø cm	ø in	H. cm	H. in
V87 05 42 CS4	7,6	30	9,5	3,3/4

**Anello Urban Organizer**

Urban Organizer ring
 Anneau Urban organizer
 Edelstahlring für Urban-Organizer
 Anillo Urban Organizer

Acciaio Inox 18/10 - St. Steel 18/10

	ø cm	ø in
V87 05 42 A01	9	35,3/8

**Vassoio Urban Organizer**

Urban Organizer tray
 Plateau Urban Organizer
 Edelstahl Tablett für Urban Organizer
 Bandeja Urban Organizer

Acciaio Inox 18/10 - St. Steel 18/10

	cm	in
V87 05 42 V01	20x19	7,7/8x7,1/2

**Base per Tower Urban Organizer verniciata con perni**

Urban Organizer varnished, stand with pins
 Support Urban Organizer verni avec pivots
 Lackiert Gestell für Urban Tower, mit Zapfen
 Soporte Urban Organizer varnizado con pivotes

Ferro Verniciato - Varnished Iron

	cm	in
V87 05 42 B02	30x30	11,3/4x11,3/4

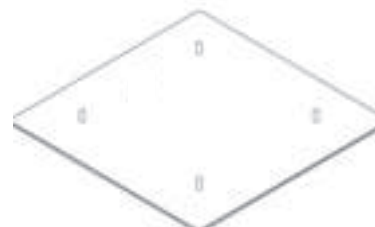





Mix&Play Revolution

Un'idea nuova ed originale nel concetto Buffet: **Mix&Play Revolution** consente con un tocco di creatività e fantasia di presentare cibi, bevande, stuzzichini ecc. ispirandosi ai diversi momenti di consumo (dalla colazione all'aperitivo) e alle tipologie dei locali. Un'opera d'arte che coniuga modernità e funzionalità in un prodotto che non ha eguali.

Le strutture in alluminio sono state pensate per soddisfare le differenti esigenze di spazio e di consumo del cliente. Sono l'esempio per eccellenza del concetto modulare consentendo la composizione di 5 differenti misure delle basi (2 quadrate e 3 rettangolari) per 3 differenti altezze. Con la creatività è possibile adattare **Mix&Play Revolution** Buffet al proprio spazio e creare sempre nuove ed originali presentazioni.

7 nuove composizioni studiate per facilitare la creazione del vostro buffet.

A new and original idea for the buffet: **Mix&Play Revolution** allows to present food and beverages etc. at different times of the day and different kinds of place, with an incredible touch of creativity and fantasy. A work of art that matches modern day practicality in just one product. The only one!

The metal podio are created to satisfy the different needs of space and consumption. They are easy excellent example of modular concept allowing the composition of 5 different sizes of base (2 square and 3 rectangular) for 3 different heights. By being creative it is possible to adapt **Mix&Play Revolution** Buffet to any kind of space and always provide new and fantastic Buffet.

7 new arrangements studied to make the preparation of your buffet easier.

Set 1

V86 32 42 003 Nero-Black
V86 32 42 010 Silver-Silver

cm	H. cm	in	H. in
52,5x70	24	20,5/8x27,1/2	9,1/2



Set 2

V86 32 42 004 Nero-Black
V86 32 42 011 Silver-Silver

cm	H. cm	in	H. in
35x70	24	13,3/4x27,1/2	9,1/2



Set 3

V86 32 42 005 Nero-Black
V86 32 42 012 Silver-Silver

cm	H. cm	in	H. in
52,5x70	22,5	20,5/8x27,1/2	8,7/8



Set 4

V86 32 42 006 Nero-Black
V86 32 42 013 Silver-Silver

cm	H. cm	in	H. in
52,5x70	22,5	20,5/8x27,1/2	8,7/8



Set 5

V86 32 42 007 Nero-Black
V86 32 42 014 Silver-Silver

cm	H. cm	in	H. in
52,5x70	16	20,5/8x27,1/2	6,1/4



Set 6

V86 32 42 008 Nero-Black
V86 32 42 015 Silver-Silver

cm	H. cm	in	H. in
52,5x52,5	16	20,5/8x20,5/8	6,1/4



Set 7

V86 32 42 009 Nero-Black
V86 32 42 016 Silver-Silver

cm	H. cm	in	H. in
52,5x52,5	16	20,5/8x20,5/8	6,1/4



Alzata modulare quadrata

Square modular podium
Etagère modulaire carrée
Modulständer, viereckig
Expositor modular cuadrado

	cm	H. cm	in	H. in
Argento - Silver				
V86 11 42 Q01	17,5x17,5	9,5	6,7/8x6,7/8	3,3/4
V86 11 42 Q02	17,5x17,5	16	6,7/8x6,7/8	6,1/4
V86 11 42 Q03	17,5x17,5	22,5	6,7/8x6,7/8	8,7/8
Nero - Black				
V86 15 42 Q01	17,5x17,5	9,5	6,7/8x6,7/8	3,3/4
V86 15 42 Q02	17,5x17,5	16	6,7/8x6,7/8	6,1/4
V86 15 42 Q03	17,5x17,5	22,5	6,7/8x6,7/8	8,7/8



Alzata modulare quadrata

Square modular podium
Etagère modulaire carrée
Modulständer, viereckig
Expositor modular cuadrado

	cm	H. cm	in	H. in
Argento - Silver				
V86 11 42 Q04	35x35	9,5	13,3/4x13,3/4	3,3/4
V86 11 42 Q05	35x35	16	13,3/4x13,3/4	6,1/4
V86 11 42 Q06	35x35	22,5	13,3/4x13,3/4	8,7/8
Nero - Black				
V86 15 42 Q04	35x35	9,5	13,3/4x13,3/4	3,3/4
V86 15 42 Q05	35x35	16	13,3/4x13,3/4	6,1/4
V86 15 42 Q06	35x35	22,5	13,3/4x13,3/4	8,7/8



Alzata modulare rettangolare

Rectangular modular podium
Etagère modulaire rectangulaire
Modulständer, rechteckig
Expositor modular rectangular

	cm	H. cm	in	H. in
Argento - Silver				
V86 11 42 R01	17,5x35	9,5	6,7/8x13,3/4	3,3/4
V86 11 42 R02	17,5x35	16	6,7/8x13,3/4	6,1/4
V86 11 42 R03	17,5x35	22,5	6,7/8x13,3/4	8,7/8
Nero - Black				
V86 15 42 R01	17,5x35	9,5	6,7/8x13,3/4	3,3/4
V86 15 42 R02	17,5x35	16	6,7/8x13,3/4	6,1/4
V86 15 42 R03	17,5x35	22,5	6,7/8x13,3/4	8,7/8



Alzata modulare rettangolare

Rectangular modular podium
Etagère modulaire rectangulaire
Modulständer, rechteckig
Expositor modular rectangular

	cm	H. cm	in	H. in
Argento - Silver				
V86 11 42 R04	17,5x52,5	9,5	6,7/8x20,5/8	3,3/4
V86 11 42 R05	17,5x52,5	16	6,7/8x20,5/8	6,1/4
V86 11 42 R06	17,5x52,5	22,5	6,7/8x20,5/8	8,7/8
Nero - Black				
V86 15 42 R04	17,5x52,5	9,5	6,7/8x20,5/8	3,3/4
V86 15 42 R05	17,5x52,5	16	6,7/8x20,5/8	6,1/4
V86 15 42 R06	17,5x52,5	22,5	6,7/8x20,5/8	8,7/8



Alzata modulare rettangolare

Rectangular modular podium
Etagère modulaire rectangulaire
Modulständer, rechteckig
Expositor modular rectangular

	cm	H. cm	in	H. in
Argento - Silver				
V86 11 42 R07	35x52,5	9,5	13,3/4x20,5/8	3,3/4
V86 11 42 R08	35x52,5	16	13,3/4x20,5/8	6,1/4
V86 11 42 R09	35x52,5	22,5	13,3/4x20,5/8	8,7/8
Nero - Black				
V86 15 42 R07	35x52,5	9,5	13,3/4x20,5/8	3,3/4
V86 15 42 R08	35x52,5	16	13,3/4x20,5/8	6,1/4
V86 15 42 R09	35x52,5	22,5	13,3/8x20,5/8	8,7/8



Piano legno quadrato

Square wooden base
Tablette en bois carrée
Holzplatte, viereckig
Tablero de madera cuadrado

	cm	H. cm	in	H. in
V86 04 42 PQ1	17,5x17,5	0,8	6,7/8x6,7/8	0,3/8



Piano legno rettangolare

Rectangular wooden base
Tablette en bois rectangulaire
Holzplatte, rechteckig
Tablero de madera rectangular

	cm	H. cm	in	H. in
V86 04 42 PR1	17,5x35	0,8	6,7/8x13,3/4	0,3/8



Supporto legno inclinato quadrato

Square modular podium
Etagère modulaire carrée
Holzgestell, viereckig, schräg gestellt
Expositor modular cuadrado

	cm	H. cm	in	H. in
V86 04 42 SQ1	35x35	7,5	13,3/4x13,3/4	3



Supporto legno inclinato rettangolare

Rectangular modular podium
Etagère modulaire rectangulaire
Holzgestell, viereckig, schräg gestellt
Expositor modular rectangular

	cm	H. cm	in	H. in
V86 04 42 SR1	35x52,5	7,5	17,3/4x20,5/8	3



Vassoio legno quadrato

Square wooden tray
Plateau en bois carrée
Holztablett, viereckig
Bandeja de madera cuadrado

	cm	H. cm	in	H. in
V86 04 42 VQ1	35x35	4	13,3/4x13,3/4	1,1/2
V86 04 42 VQ2	35x35	8	13,3/4x13,3/4	3,1/8



Vassoio legno rettangolare

Rectangular wooden tray
Plateau en bois rectangulaire
Holztablett, rechteckig
Bandeja de madera rectangular

	cm	H. cm	in	H. in
V86 04 42 VR1	17,5x35	4	6,7/8x13,3/4	1,1/2
V86 04 42 VR2	17,5x35	8	6,7/8x13,3/4	3,1/8



Vassoio legno rettangolare

Rectangular wooden tray
Plateau en bois rectangulaire
Holztablett, rechteckig
Bandeja de madera rectangular

	cm	H. cm	in	H. in
V86 04 42 VR3	17,5x52,5	4	6,7/8x20,5/8	1,1/2
V86 04 42 VR4	17,5x52,5	8	6,7/8x20,5/8	3,1/8



Vassoio legno rettangolare

Rectangular wooden tray
Plateau en bois rectangulaire
Holztablett, rechteckig
Bandeja de madera rectangular

	cm	H. cm	in	H. in
V86 04 42 VR5	35x52,5	4	13,3/4x20,5/8	1,1/2
V86 04 42 VR6	35x52,5	8	13,3/4x20,5/8	3,1/8



Piatto quadrato porcellana

Square porcelain platter
 Plat carré en porcelaine
 Porzellanteller, viereckig
 Plato cuadrado de porcellana

	cm	in
V86 21 42 PQP	17,5x17,5	6,7/8x6,7/8



Piatto quadrato porcellana

Square porcelain platter
 Plat carré en porcelaine
 Porzellanteller, viereckig
 Plato cuadrado de porcellana

	cm	in
V86 21 42 PQG	35x35	13,3/4x13,3/4



Piatto rettangolare porcellana

Rectangular porcelain platter
 Plat rectangulaire en porcelaine
 Porzellanteller, rechteckig
 Plato rectangular de por

	cm	in
V86 21 42 PRE	17,5x35	6,7/8x13,3/4



Teglia rettangolare in porcellana

Rectangular porcelain baker
 Plate a roti rectangular en porcelaine
 Porzellanbackform, rechteckig
 Fuente rectangular porcelana

	cm	in
V86 21 42 TRE	17,5x35	6,7/8x13,3/4



Teglia quadrata in porcellana

Square porcelain baker
 Plate a roti carré en porcelaine
 Porzellanbackform, viereckig
 Fuente cuadrada de porcelana

	cm	in
V86 21 42 TQU	35x35	13,3/4x13,3/4



Ciotola quadra porcellana

Porcelain bowl
 Bol carré en porcelaine
 Porzellanschale, viereckig
 Bol cuadrado de porcellana

	cm	H. cm	in	H. in
V86 21 42 CQ14	14x14	8	5,1/2x5,1/2	3,1/8
V86 21 42 CQ7	7x7	3,5	2,3/4x2,3/4	1,3/8



Bicchiere vetro

Glass glass
 Verre Ginco
 Glass, klein
 Vaso cristal bajo

	ø cm	H. cm	lt
V86 08 42 BBA	6	8	0,10
	ø in	H. in	oz
	2,3/8	3,1/8	3,5
V86 08 42 BAL	7	11	0,15
	ø in	H. in	oz
	2,3/4	4,3/8	5



Coppa in vetro

Glass bowl
 Coupelle en verre
 Glasschale
 Bol de vidrio

	ø cm	H. cm	ø in	H. in
V86 08 42 C12	12	7	4,3/4	2,3/4



Protezione buffet chiusa

Buffet protection closed
 Protection buffet fermée
 Buffetschutz geschlossen
 Protección buffet cerrada

Plexiglass

	cm	in
V77 12 81 001	34x73xh51	13,3/8x28,3/4xh20,1/8

Protezione buffet aperta

Buffet protection open
 Protection buffet ouverte
 Buffetschutz offen
 Protección buffet abierta

Plexiglass

	cm	in
V77 12 81 002	34x73xh51	13,3/8x28,3/4xh20,1/8



Distributore succhi

Juice dispenser
 Distributeur jus
 Saftdispenser
 Dispensadro de zumo

	lt	oz	cm	H. cm	in	H. in
V76 05 52 00 8R	3,5	118	20x31,5	51	7,3/4x12,1/2	20
V76 05 52 00 2R	7	237	27x37	56	10,5/8x14,1/2	22
V76 05 52 01 2R	12	405	27x37	51	10,5/8x14,1/2	20



Portaformaggi-affettati rettangolare refrigerato

Thermal rectangular cheese dish
 Plateau fromage - charcuterie rectangulaire réfrigérant
 Rechteckige Aufschnittplatte, gekühlt
 Quesera rectangular refrigerante

	cm	H. cm	in	H. in
V76 05 54 R0 1R	50x30	20	19,3/4x11,3/4	7,7/8





Distributore caffè

Coffee urn
Distributeur de café
Kaffeedispenser
Dispensador de café

	lt	cm	Hcm
V76 05 52 00 1R	10	26x33	64
	oz	in	H. in
	350	10,1/4x13	25,1/8



Distributore cereali singolo

Cereal dispenser
Distributeur céréales
Müeslidispenser
Dispensador de cereales

	lt	cm	Hcm
V76 05 52 01 0R	4	19,5x29	56
	oz	in	
	135	7,3/4x11,3/822	

	lt	cm	Hcm
V76 05 52 01 1R	7	19,5x29	70
	oz	in	
	237	7,3/4x11,3/827,7/8	

Buffet Square





Portaformaggi-affettati rettangolare refrigerato Square

Thermal rectangular cheese dish Square
 Plateau fromage-charcuterie rectangulaire réfrigérant Square
 Rechteckige Aufschnittplatte, gekühlt, Square
 Quesera rectangular refrigerante Square

Acciaio Inox 18/10 - St. Steel 18/10

	cm	H. cm	in	H. in
V76 05 54 R01	50x30	20	19,5/8x11,7/8	7,7/8



Coperchio a bascula rettangolare trasparente

Transparent rectangular rolltop cover
 Cloche basculante rectangulaire transparente
 Rolltophaube-rechteckig
 Campana rectangular transparente

SAN

	cm	in
V76 12 15 R01	47x27	18,1/2x10,5/8

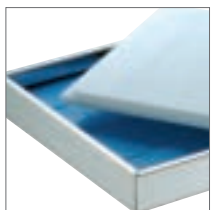

Tagliere rettangolare

Rectangular cutting board
 Planche à découper rectangulaire
 Rechteckiges Schneidebrett
 Tabla de cortar rectangular

Polietilene

	cm	in
V77 12 71 R01	47x27	18,1/2x10,5/8



4 Eutettici rettangolari

4 Ice packs
 4 Blocs réfrigérants
 4 Kühlakkus
 4 Acumuladores de frío rectangulares

1 eutettico/ 1 ice pack

V77 12 95 M00



Alzata filo per basi rettangolari

Square wire stand for rectangular bases
 Support en fil pour bases rectangulaires
 Drahtständer für rechteckigen Sockel
 Soporte filo de acero para bases rectangulares

Acciaio Inox 18/10 - St. Steel 18/10

	cm	H. cm
V76 05 42 001	50x30	27,5

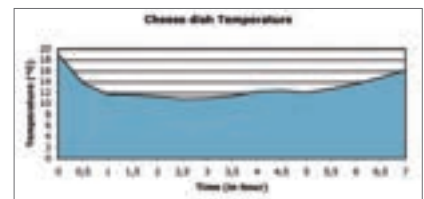

Temperatura ambiente External temperature 19,6°

Temperatura acqua Water temperature 18,9°

Mezzo refrigerante Cooler system 8 eutettici ghiaccio piccoli 8 small ice packs

Portaformaggi-affettati tondo refrigerato Square

Thermal round cheese dish Square

Plateau fromage-charcuterie rond réfrigérant Square

Runde Aufschnittplatte, gekühlt, Square

Quesera redonda refrigerante Square

Acciaio Inox 18/10 - St. Steel 18/10

	cm	H. cm	in	H. in
V76 05 54 T01	38x38	23	14,8/8x14,8/8	9



Coperchio a bascula tondo trasparente

Transparent round rolltop cover

Cloche basculante ronde transparente

Rolltophaube - rund

Campana redonda transparente

SAN

	ø cm	ø in
V76 12 15 T01	34	13,3/8



Tagliere quadrato con scanal. tonda

Square cutting board with round groove

Planche à découper carrée avec rainure ronde

Viereckiges Schneidebrett mit runder Rille

Tabla de cortar cuadrada con ranura

Polietilene

	cm	in
V77 12 71 T01	35x35	13,3/4x13,3/4



Eutettici rettangolari

Ice packs

Blocs réfrigérants

Kühlakkus

Acumuladores de frío rectangulares

1 eutettico/ 1 ice pack

V77 12 95 M00

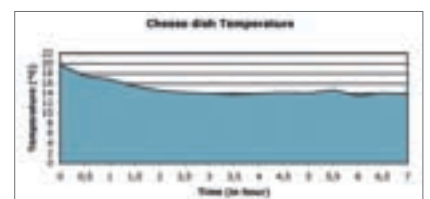

Temperatura ambiente 20,9°
External temperature

Temperatura acqua 19,5°
Water temperature

Mezzo refrigerante 4 eutettici ghiaccio piccoli
Cooler system 4 small ice packs



Distributore succhi Square

Square juice dispenser

Distributeur jus Square

Saftdispenser Square

Dispensador de zumo Square

Acciaio Inox 18/10 - St. Steel 18/10

	cm	H. cm	lt	oz
V76 05 52 008	18x27,5	46	3,5	118
V76 05 52 002	24x31	50	7	237
V76 05 52 012	24x31	70	12	405

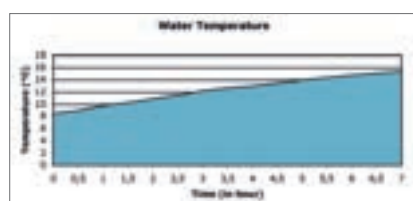

Temperatura ambiente
External temperature

20,0°

Temperatura acqua
Water temperature

7,6°

Quantità acqua inserita
Quantity of water added

7 lt

Distributore caffè Square

Coffee urn 10 lt
 Distributeur de café 10 lt
 Kaffeedispenser 10 lt
 Dispensador de café 10 lt

Acciaio Inox 18/10 - St. Steel 18/10

	cm	H. cm	lt	oz
V76 05 52 001	24x31	61	10	350



Fornelletto per scaldavivande / distributore caffè

Burner for chafing dish/coffee urn
 Porte bruleur pour chafing dish et distributeur café
 Brennstoffhalter für Chafing Dish und Kaffeedispenser
 Contenidor de combustible para chafing dish - dispensador de café

V77 05 52 FDC



Piastra elettrica per distributore caffè

Heating element for coffee urn
 Plaque électrique pour distributeur de café
 Elektro-Heizelement für Kaffeedispenser
 Plancha eléctrica para dispensador de café

V77 05 52 PDC \varnothing cm \varnothing in
 14 5,1/2

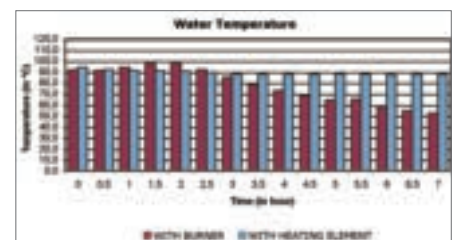

Temperatura ambiente 20,0°
 External temperature

Temperatura acqua 92,5°/98,8°
 Water temperature

Quantità acqua inserita 8 lt
 Quantity of water added

Distributore cereali singolo Square

Square cereal dispenser
Distributeur céréales Square
Muesli dispenser Square
Dispensador de cereales Square

Acciaio Inox 18/10 - St. Steel 18/10

	cm	H. cm	lt	oz
V76 05 52 010	18x27	53	4	135
V76 05 52 011	18x27	68	7	237



Tagliere per pane base acciaio Square

Square bread cutting board with St. Steel base
 Planche à découper à pain Square avec base en acier Inoxidable
 Brotschneidebrett Square mit Stahlgestell
 Tabla de cortar pan Square con base de acero Inoxidable

Acciaio Inox 18/10 - St. Steel 18/10

	cm	in
V76 05 54 001	50x30	19,5/8x11,7/8

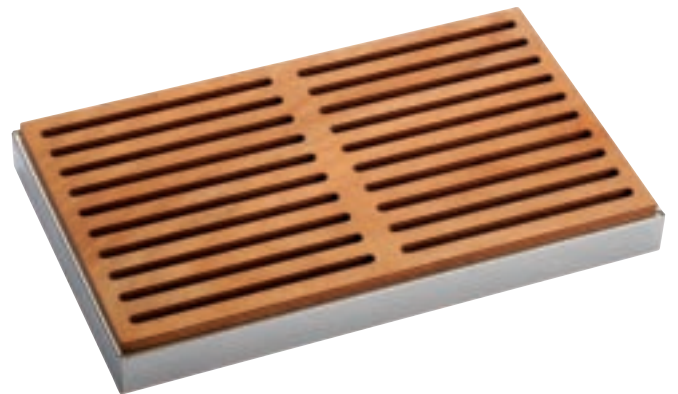
**Cestino pane acciaio per buffet Square**

Square bread basket for buffet, St. Steel
 Corbeille à pain en acier pour buffet Square
 Brotkorb Square für Buffet, Edelstahl
 Cesta pan en acero para buffet Square

Acciaio Inox 18/10 - St. Steel 18/10

	cm	in
V76 05 24 001	50x30	19,5/8x11,7/8

**Scaldabrioche Square con termostato**

Square croissant warmer
 Chauffe - croissants Square
 Croissantwärmer Square
 Calentador croissants Square

Acciaio Inox 18/10 - St. Steel 18/10

	cm	in
V76 05 52 020	47,5x28	18,3/4x11



402 • Buffet Square

Portamacedonia Square

Square yogurt/fruit-salad holder without lid
Porte-salade de fruits/yogourt sans couvercle Square
Joghurt/Obstsalatbehälter ohne Deckel Square
Porta yogur/ensalada de frutas refrigerado sin tapa Square

Acciaio Inox 18/10 - St. Steel 18/10

	cm	in
V76 05 52 017	24x24	6,7/8x6,7/8

Con coperchio - with lid

V76 05 52 007	24x24	6,7/8x6,7/8
---------------	-------	-------------

Senza coperchio - without lid



Coperchio metacrilato c/pomolo Square

Acrylic lid with knob Square
Couvercle acrylique avec pommeau Square
Deckel aus Acryl mit wvquare
Tapa acrílica con perilla Square

	ø cm	ø in
310 12 15 797	23	9



Ciotola in vetro

Glass bowl
Bol en verre
Glasschale
Bol de vidrio

	ø cm	ø in
310 08 42 527	23	9



Disco copri eutettici

Ice pack cover
Disc pour blocs réfrigérants
Disco para acumuladores de frío
Kühlakkus Scheibe

	ø cm	ø in
Z76 60 52 007	24	9,1/2



3 Eutettici rettangolari

3 Ice packs
3 Blocs réfrigérants
3 Kühlakkus
3 Acumuladores de frío rectangulares

1 eutettico/ 1 ice pack

V77 12 95 M00



Contenitore in metallo porta macedonia /eutettico Square

Square metal fruit salad holder 24x24 cm w/o ice pack
Conteneur en métal pour salade de fruits sans bloc réfrigérant Square
Metalbehälter ohne Kühlakkus Square
Porta ensalada de frutas en metal Square sin acumuladore de frío

	cm	in
Z76 20 52 007	24x24	6,7/8x6,7/8



Portayogurt/marmellata refrigerato Square

Square thermal yogurt/jam holder for pitcher

Rafrâichisseur yaourt/confiture Square

Joghurt/Marmeladebehälter, gekühlt Square

Portayogur/mermelada refrigerado Square

Acciaio Inox 18/10 - St. Steel 18/10

	cm	H. cm	in	H. in
V76 05 52 014	17,5x17,5	7	6,7/8x6,7	3,3/4

Con coperchio - with lid

V76 05 52 004	17,5x17,5	7	6,7/8x6,7	3,3/4
---------------	-----------	---	-----------	-------

Senza coperchio - without lid

Coperchio porta yogurt c/pomolo Square

Square lid with knob for yogurt holder

Couvercle sans pomole pour porte-yaourt Square

Deckel für Joghurtbehälter Square

Tapa para portayogur sin perilla Square

	ø cm	ø in
Z76 01 52 004	15	6

Ciotola in vetro

Glass bowl

Bol en verre

Glasschale

Bol en vidrio

	ø cm	ø in	lt	oz
V76 08 52 004	15	6	0,5	17

Disco copri eutettici

Ice pack cover

Disc pour blocs réfrigérants

Kühllakus Scheibe

Disco para acumuladores de frío

	ø cm	ø in
Z76 60 52 005	15	6

Eutettici tondi

Round ice packs

Blocs réfrigérants ronds

Abdeckungscheibe für Kühllakus

Acumuladores de frío rectangulares

	ø cm	ø in
V77 12 95 T01	14,5	5,3/4

Contentitore in metallo porta caraffe/yogurt s/eutettico Square

Square pitcher/yogurt holder w/out ice pack

Conteneur en métal pour carafes/yaourt sans bloc réfrigérant Square

Metalbehälter ohne Kühllakus Square

Portayogur/jarra sin acumulador de frío Square

	cm	H. cm	in	H. in
Z76 20 52 004	17,5x17,5	7	6,7/8x6,7	3,3/4



Portacaraffa con coperchio refrigerato Square

Square thermal pitcher holder with lid
 Porte-carafe avec couvercle réfrigérante Square
 Karaffenträger mit Deckel, gekühlt Square
 Soporte refrigerado para jarra con tapa Square

Acciaio Inox 18/10 - St. Steel 18/10

	lt	oz
V76 05 52 005	1,5	50
Con coperchio-with lid		

V76 05 52 006	1,5	50
Senza coperchio-without lid		



Coperchio caraffa in acciaio per brocca

St. Steel lid for juice pitcher
 Couvercle en acier pour carafe
 Edelstahl Deckel für Karaffe
 Tapa en acero para jarra

	ø cm	ø in
Z76 01 52 005	10	4



Caraffa vetro

Glass pitcher
 Carafe en verre
 Saftkanne
 Jarra de zumo

	lt	oz
V76 08 52 009	1,5	50
Senza coperchio-without lid		

V76 08 52 005	1,5	50
Con coperchio-with lid		



Disco copri eutettici

Ice pack cover
 Disc pour blocs réfrigérants
 Kühlakkus Scheibe
 Disco para acumuladores de frío

	ø cm	ø in
Z76 60 52 005	15	6



Eutettici tondi

Round ice packs
 Blocs réfrigérants ronds
 Kühlakkus rund
 Acumuladores de frío rectangulares

	ø cm	ø in
V77 12 95 T01	14,5	5,3/4



Contenitore in metallo porta caraffe/yogurt s/eutettico Square

Square pitcher/yogurt holder w/o ice pack
 Conteneur en métal pour carafes/yaourt sans bloc réfrigérant Square
 Metalbehälter ohne Kühlakkus Square
 Portayogur/jarra sin acumulador de frío Square

	cm	H. cm	in	H. in
Z76 20 52 004	17,5x17,5	7,5	6,7/8x6,73	





Portacaraffe con sistema refrigerante

Thermal pitcher 4-pc set
 Rafrâchisseur à carafes
 Thermo-Karaffenthaler 4 Stck.
 Enfriador para 4 jarras

Acciaio Inox 18/10 - St. Steel 18/10

	cm	H. cm	in	H. in
V76 05 52 021	24x24	7,5	9,1/2x9,1/2	3

Caraffe non incluse - Water jugs not included



Caraffa acqua con coperchio basculante

Water glass pitcher with smart lid
 Carafe en verre avec couvercle basculant
 Wasserkaraffe
 Jarra de vidrio con tapa basculante

Vetro - Glass

	lt	oz
V76 08 52 007	1	35
Grigio - Grey		
V76 08 52 007 35	1	35
Avio - Avio		
V76 08 52 007 07	1	35
Rosso - Red		

Rinfresca caraffe con sistema refrigerante

Thermal pitcher
 Rafrâchisseur à carafes
 Thermo-Karaffenthaler
 Enfriador de botallas

Acciaio Inox 18/10 - St. Steel 18/10

	ø mm	H. cm	ø in	H. in
V76 055 20 23	135	5	5,3/8	2

con eutettico - with ice pack
 caraffa esclusa - without pitcher



Eutettico per rinfresca caraffe

Ice pack for thermal pitcher
 Bloc réfrigérant pour rafrâchisseur à carafes
 Kühlelemente für Thermo-Karaffenthaler
 Acumulador de frio para enfriador de botallas

Polietilene - Polyethylene

	ø mm	H. cm	ø in	H. in
V77 12 95 T02	75	2,5	3	1

Corpo per porta caraffa

Container for thermal pitcher
 Conteneur pour rafrâchisseur à carafes
 Behälter für Thermo-Karaffenthaler
 Contenedor para enfriador de botallas

Acciaio Inox 18/10 - St. Steel 18/10

	ø mm	H. cm	ø in	H. in
Z76 20 52 023	135	5	5,3/8	2



Jambee

Un oggetto **elegante e contemporaneo**, adatto a ogni tipo di buffet: grazie al design unico e innovativo.

I materiali usati sono di **alto livello qualitativo** - acciaio Inox 18/10 e metacrilato - e rendono il distributore un oggetto pregiato.

MADE IN ITALY

La **tecnologia semplice**, ma al tempo stesso funzionale, permette di erogare dosi da 8gr (0.28 oz) di prodotto, riducendo gli sprechi ed eliminando le monoporzioni da 25gr (0.88 oz).

Questo consente un risparmio di prodotto e la riduzione dei rifiuti

nel rispetto dell'ambiente. inoltre è ideale per servire miele e marmellate di produzione artigianale, per fornire un prodotto di alto livello e che soddisfi anche i clienti più esigenti.

Un ottimo modo per arricchire l'esperienza della colazione, mantenendo **ordinato e pulito** il buffet.

Utilizzabile con prodotti erogabili semisolidi, come confetture, marmellate - pure con piccoli frammenti di frutta - e creme, ma anche con miele, sciroppi e salse di analoga consistenza.

Jambee è l'ideale per **ogni struttura ricettiva**: alberghi, pasticcerie, bar e ristoranti.



An **elegant and modern** object for all buffets, thanks to its unique and innovative design.

The materials used are **high quality** – 18/10 stainless steel and methacrylate – which makes the dispenser a fine object.

MADE IN ITALY

Its **simple technology**, though functional, allows to dispense 8 gr (0.28 oz) product doses, to reduce waste and get rid of 25 gr (0.88 oz) single dose jars.

That allows, as well, to save on product and reduce waste, respecting the environment.

Moreover, it is the ideal to dispense honey and homemade jams, in order to supply for a high-end product, capable of meeting even the most demanding customers' needs.

The best way to make the most of the breakfast experience, keeping the buffet **tidy and clean**.

It can be used with dispensable semisolid products like preserves, marmalades – even with small fruit pieces in them – , creams and honey, syrups and sauces as well, which have the same consistency.

Jambee is the ideal for **any accommodation facility**: hotels, pastry shops, bars and restaurants.

Jambee

Acciaio Inox 18/10 - St. Steel 18/10

	lt	oz	cm	in
V77 0552 DMB	0,7	24	12,5x34,5 H Min 44,5 H Max 58	5x13,5/8 H Min 17,1/2 H Max 22,7/8
V77 0552 DMC	1	35	12,5x34,5 H Min 48 H Max 71,5	5x13,5/8 H Min 18,3/4 H Max 28,1/8



Erogatore a siringa

Syringe nozzle
Embout seringue
AusgieBerspritze
Boquilla jeringa

Acciaio Inox 18/10 - St. Steel 18/10

Z77 4652 DMA



Erogatore standard

Standard nozzle
Embout standard
Standard AusgieBer
Boquilla estandar

Acciaio Inox 18/10 - St. Steel 18/10

Z77 4552 DMA

Pistone con coperchio

Piston with lid
Piston avec couvercle
Kolben mit Deckel
Pistón con tapa

**Acciaio Inox 18/10, Metacrilato e PP
St. Steel 18/10, Methacrylate and PP**

lt

Z77 9852 DMA 0,7
Z77 9852 DMA1 1

Contentitore

Container
Conteneur
Behälter
Contenedor

Metacrilato - Methacrylate

lt

Z77 2052 DMA 0,7
Z77 2052 DMA1 1

Targhetta porta etichetta

Label plate
Plaque porte-étiquette
Schild Etikettenhalter
Placa porta etiqueta

Metacrilato - Methacrylate**Z77 5752 DMA1****Porta coppette linea Jambee (adatta a contenere 50 coppette)**

Jambee bowl-holder with transparent bowls
Porte-bols avec bols transparents Jambee
Glasschalebehälter mit Glasschalen Jambee
Porta boles con boles transparentes Jambee

Acciaio Inox 18/10 - St. Steel 18/10

	Ø cm	H. cm	Ø in	H. in
V77 05 09 C01	15	26,5	5,9	10,3/8

Coppetta per marmellata

Jam bowl
Bol pour marmelade
Marmeladeschale
Bol para marmelada

Vetro - Glass

	Ø cm	Ø in
V77 08 09 001	6	2,3/8

Tappo

Cap
Capsule
Stöpsel
Tapón

Metacrilato - Methacrylate**Z77 1352 DMA****Contentitore completo**

Complete container
Conteneur complet
Komplett Behälter
Contenedor completo

Metacrilato - Methacrylate

lt

Z77 9952 DMA 0,7
Z77 9952 DMA1 1



Buffet Imperial





Portaformaggi/affettati rettangolare completo refrigerato con base in acciaio

Thermal rectangular cheese dish

Plateau fromage-charcuterie rectangulaire réfrigéré

Käse/Wurstwarenplatte - rechteckig

Quesera rectangular refrigerante

Acciaio Inox - Polietilene

St.Steel - Polyethylene

	cm	H. cm	in	H. in
V77 05 54 G11 R	53x32,5	19	20,7/8x12,3/4	7,1/2



Coperchio a bascula rettangolare trasparente

Transparent rectangular rolltop cover

Cloche basculante rectangulaire transparente

Rolltophaube-rechteckig

Campana rectangular transparente

	cm	in
V77 12 15 G11	47x27	18,1/2x10,5/8



Tagliere rettangolare

Rectangular cutting board

Planche à découper rectangulaire

Rechteckiges Schneidebrett

Tabla de cortar rectangular

Polietilene - Polyethylene

	cm	in	Sp. mm	TH. in
V77 12 71 G11	47x27	18,1/2x10,5/8	1,5	0,5/8



Bacinella rettangolare

Rectangular pan

Cuvette rectangulaire

Schüssel - rechteckig

Cubeta rectangular

Acciaio Inox 18/10 - St. Steel 18/10

	cm	H. cm	in	H. in
V77 05 14 G11	53x32,5	3,5	20,7/8x12,3/4	1,1/8



8 Eutettici rettangolari

8 Ice packs

8 Blocs réfrigérants

8 Kühlakkus

8 Acumuladores de frío rectangulares

1 eutettico/ 1 ice pack

V77 12 95 M00

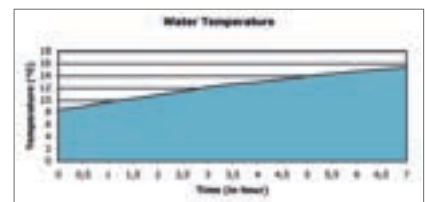

Temperatura ambiente
External temperature 19,6°

Temperatura acqua
Water temperature 18,9°

Mezzo refrigerante
Cooler system 8 eutettici ghiaccio piccoli
8 small ice pack

Portaformaggi/affettati tondo completo refrigerato con base in acciaio

Thermal round cheese dish

Plateau fromage-charcuterie rond réfrigéré

Käse/Wurstwarenplatte - rund

Quesera redonda refrigerante

Acciaio Inox - Polietilene

St. Steel - Polyethylene

	cm	H. cm	in	H. in
V77 05 54 T46 R	46	27,5	18,1/8	10,7/8



Coperchio a bascula tondo trasparente

Transparent round rolltop cover

Cloche basculante ronde transparente

Rolltophaube - rund

Campana redonda transparente

	ø cm	ø in
V77 12 15 T46	41	16,1/8



Tagliere tondo

Round cutting board

Planche ronde

Schneidebrett - rund

Tabla para cortar redonda

Polietilene - Polyethylene

	ø cm	ø in	Sp. mm	TH. in
V77 12 71 T46	41	16,1/8	2	0,3/4



Bacinella tonda

Round pan

Cuvette ronde

Schüssel - rund

Cubeta redonda

Acciaio Inox 18/10 - St. Steel 18/10

	ø cm	H. cm	ø in	H. in
V77 05 14 T46	46	5	18,1/8	2



4 Eutettici rettangolari

4 Ice packs

4 Blocs réfrigérants

4 Kühllakkus

4 Acumuladores de frío rectangular

1 eutettico/ 1 ice pack

V77 12 95 M00

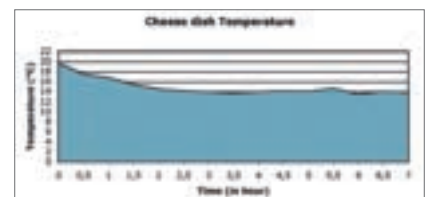

Temperatura ambiente External temperature 20,9°

Temperatura acqua Water temperature 19,5°

Mezzo refrigerante Cooler system 4 eutettici ghiaccio piccoli
4 small ice pack

Portaformaggi/affettati rettangolare completo

Rectangular cheese dish
 Plateau fromage-charcuterie rectangulaire
 Käse/Wurstwarenplatte - rechteckig
 Quesera rectangular

Acciaio Inox 18/10 - St. Steel 18/10

	cm	H. cm	in	H. in
V77 05 54 G11	53x32,5	18	20,7/8x12,3/4	7

**Portaformaggi/affettati tondo completo**

Round cheese dish
 Plateau fromage-charcuterie rond
 Käse/Wurstwarenplatte - rund
 Quesera redonda

Acciaio Inox 18/10 - St. Steel 18/10

	ø cm	H. cm	ø in	H. in
V77 05 54 T46	46	24,5	18,1/8	9,5/8

**Tagliere per pane con base acciaio**

Bread cutting board
 Planche à découper à pain
 Tabla de cortar pan
 Brotschneidebrett

Acciaio Inox 18/10 - St. Steel 18/10

	cm	H. cm	in	H. in
V01 05 54 004	53x32,5	3,5	20,7/8x12,3/4	1,1/8



Portayogurt

Yogurt tray
 Plateau porte-yogourt
 Joghurtplatte
 Bandeja yogur

Acciaio Inox 18/10 - St. Steel 18/10

	∅ cm	∅ in	H. cm	H. in
V77 05 52 T46	46	18,1/8	5	2



Portaburro/crostacei

Butter tray
 Plateau porte-beurre/crustacés
 Butter/Krustazeenplatte
 Bandeja mantequilla

Acciaio Inox 18/10 - St. Steel 18/10

	∅ cm	∅ in	H. cm	H. in
V77 05 09 T32	32	12,5/8	5	2
V77 05 09 T46	46	18,1/8	5	2

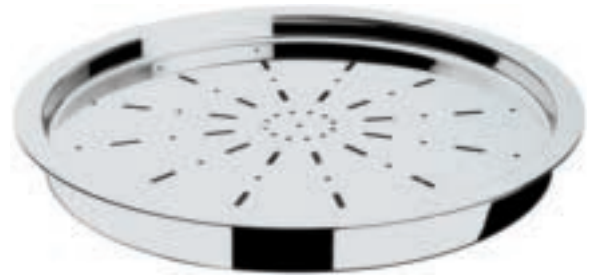

Rinfrescamacedonia/yogurt con contenitore ghiaccio esterno in acciaio con coperchio

Fruit-salad/yogurt cooler with outer ice container and lid
 Rafrâchisseur salade de fruits/yogourt avec récipient à glace externe avec couvercle
 Joghurt/Obstsalatbehälter mit Edelstahl - Eisbehälter außen mit Deckel
 Portaensalada de frutas/yogur refrigerado con recipiente para hielo externo con tapa

Acciaio Inox - St. Steel

	∅ int. cm	∅ int. in	∅ est. cm	∅ est. in
V77 05 43 YOG	23	9	28	11



Imperial scaldavivande rettangolare con coperchio rotante inox

Imperial rectangular chafing dish
Chafing dish rectangulaire Imperial
Chafing dish rectangular Imperial
Chafing Dish rechteckig Imperial

Acciaio Inox 18/10 - St. Steel 18/10

	GN	cm	H. cm	in	H. in
V77 05 52 CHR	1/1	65,5x48	44	25,3/4x19	17,3/8

Con:

Coperchio rotante a scomparsa
Portavivande 1/1 Gastronorm
2 bruciatori per pasta - combustibile
Predisposto per piastra elettrica

With:

Rolltop
1/1 gastronorm food pan
2 solid fuel burners.
Electric heating element
(available as optional)



Fornelletto per scaldavivande

Chafing-dish burner
Porte-brûleur pour chafing dish
Brennstoffhalter für Chafing Dish
Contenedor de combustible para chafing dish

V77 05 52 FDC



Piastra elettrica

Electric hot plate
Plaque électrique
Elektrische Platte
Placa eléctrica

Con regolatore - With regulator

V770552PCR2 Piastra elettrica con regolatore per scaldavivande 1/1 V230

Con fornelli

Whit burners

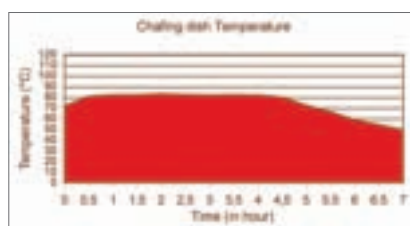

Temperatura ambiente External temperature	20,3°
Temperatura acqua Water temperature	94°
Quantità acqua inserita Quantity of water added	6 lt.
Fonte di calore Heat source	2 fornelli a fiamma 2 burners

Con piastra elettrica

Whit heating element

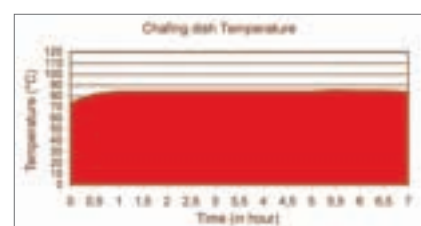

Temperatura ambiente External temperature	20,3°
Temperatura acqua Water temperature	94°
Quantità acqua inserita Quantity of water added	6 lt.
Fonte di calore Heat source	piastra elettrica heating element

Scaldavivande tondo con coperchio rotante

Round rolltop chafing dish

Chafing dish rond avec couvercle pivotant

Chafing Dish - rund mit Rolltophaube

Calientaplatos redondo con campana

Acciaio Inox 18/10 - St. Steel 18/10

	∅ cm	H. cm	∅ in	H. in
V77 05 52 CHT	50	46	15,3/4	18,1/8

Con:

Coperchio rotante a scomparsa

Portavivande ∅ 40 cm

1 bruciatore per pasta - combustibile

Predisposto per piastra elettrica

With:

Rolltop

Food pan ∅ 40 cm

Solid fuel burners.

Electric heating element

(available as optional)



Fornelletto per scaldavivande

Chafing-dish burner

Porte-brûleur pour chafing dish

Brennstoffhalter für Chafing Dish

Contenedor de combustible para chafing dish

V77 05 52 FDC



Piastra elettrica

Electric hot plate

Plaque électrique

Elektrische Platte

Placa eléctrica

Con regolatore - With regulator

V770552PCT2

Piastra elettrica con regolatore per scaldavivande 2/3 V230

Con fornelli

Whit burners

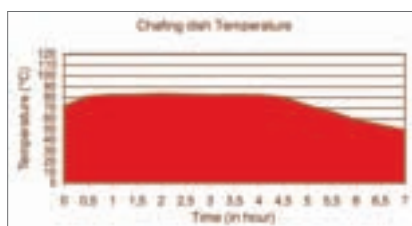

Temperatura ambiente External temperature	20,3°
Temperatura acqua Water temperature	94°
Quantità acqua inserita Quantity of water added	6 lt.
Fonte di calore Heat source	2 fornelli a fiamma 2 burners

Con piastra elettrica

Whit heating element

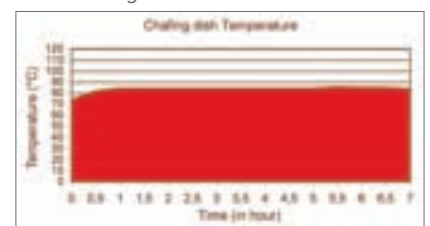

Temperatura ambiente External temperature	20,3°
Temperatura acqua Water temperature	94°
Quantità acqua inserita Quantity of water added	6 lt.
Fonte di calore Heat source	piastra elettrica heating element

Portavivande in porcellana

Food pan, porcelain
Bac en porcelaine
Porzellanbehälter
Cubeta de porcelana

	GN	cm	in
V01 21 52 G11B	1/1	53x32,5x6,5	20,7/8x12,3/4x2,1/2
V01 21 52 G23B	2/3	35,3x32,5x6,5	13,3/4x12,3/4x2,1/2
V01 21 52 G12B	1/2	26,5x32,5x6,5	10,3/8x12,3/4x2,1/2
V01 21 52 G13B	1/3	17,6x32,5x6,5	6,7/8x12,3/4x2,1/2



Portavivande tondo in porcellana

Round food pan, porcelain
Bac rond en porcelaine
Porzellanbehälter, rund
Cubeta redonda de porcelana

	ø cm	ø in
V01 21 52 T40	40	15,3/4



Inserto scaldavivande tondo in porcellana

Food pan half round chafing dish, porcelain with divider
Bac double en porcelaine pour chafing dish rond
Porzellaninsatz, 2tlg für Chafing Dish
Cubeta avec separation de porcelana para chafing dish redondo

	ø cm	ø in
V01 21 71 T12 (1 pz.)	40	15,3/4



Set zuppiere per scaldavivande tondo

Soup tureen set for cm. 40 round chafing dish
Set de soupières pour chafing dish rond
Suppenschüssel für Chafing Dish rund
Set de soperas para chafing dish redondo

Acciaio Inox 18/10 - St. Steel 18/10

	ø cm	ø in	lt	oz
V77 05 52 ACT	40	15,3/4	4,2	142



Set minstre per scaldavivande rettangolare

Soup tureen set for rectangular chafing dish
Set de soupières pour chafing dish rectangulaire
Suppenschüssel für Chafing Dish rechteckig
Set de soperas para chafing dish rectangular

Acciaio Inox 18/10 - St. Steel 18/10

	GN	lt	oz
V77 05 52 ACR	1/1	4,2	142



Porta cereali girevole a 3 comparti*

Triple rotating cereal holder
 Distributeur céréales pivotant à 3 compartiments
 Büffet-Ständer - drehbar mit 3 Glasschalen
 Dipensador de cereales giratorio 3 sectores

Acciaio Inox 18/10 - St. Steel 18/10

	∅ cm	∅ in
V77 05 52 CER 3	42	16,1/2



Porta cereali girevole a 6 comparti*

6-dish rotating cereal holder
 Distributeur céréales pivotant à 6 compartiments
 Büffet-Ständer - drehbar mit 6 Glasschalen
 Dipensador de cereales giratorio 6 sectores

Acciaio Inox 18/10 - St. Steel 18/10

	∅ cm	∅ in
V77 05 52 CER	42	16,1/2 in



*Sono escluse le ciotole in vetro
 *Without glass bowls

Ciotola in vetro

Glass bowl
 Bol en verre
 Glasschale
 Bol de vidrio

	∅ cm	∅ in	lt	oz
310 08 42 527	23	9	1,3	60



Coperchio in metacrilato

Acrylic lid
 Couverture acrylique
 Deckel aus Metakryl
 Tapa acrílica

	∅ cm	∅ in
310 12 15 795	23	9

Con pomolo in metacrilato - With acrylic knob

	∅ cm	∅ in
310 12 15 790	23	9

Con pomolo in acciaio Inox - With St. Steel knob



Distributore cereali girevole a 3 comparti con base in acciaio

Triple rotating cereal dispenser with stainless steel base

Distributeur céréales pivotant à 3 compartiments avec base en acier Inoxidable

3-Müslidispenser-drehbar mit Stahlboden

Dispensador de cereales giratorio 3 sectores con base de acero Inoxidable

Acciaio Inox 18/10 - St. Steel 18/10

	ø cm	H. cm	ø in	H. in	lt	oz
V77 05 52 CD6	42	60	16,1/2	23,5/8	3 (x3)	101 (x3)

Con:

Contentore removibile

Pomolo in metallo

Spazzola interna

Girandola dosatrice

With:

Removable container

Metal knob

inner brush

Doser handle



Contentore removibile

Consente di riempirlo e pulirlo facilmente

Removable container

It allows to be filled in and cleaned easily



Spazzola interna

non rompe i cereali

inner brush

that does not break cereals



Dettaglio pomolo in metallo

Detail of metal knob



Girandola dosatrice

Doser handle



Distributore cereali a 2 comparti con base in acciaio

Double cereal dispenser with stainless steel base

Distributeur céréales à 2 compartiments avec base en acier Inoxidable

2-Müslidispenser mit Stahlboden

Dispensador de cereales 2 sectores con base de acero Inoxidable

Acciaio Inox 18/10 - St. Steel 18/10

	cm	H. cm	in	H. in	lt	oz
V77 05 52 CD5	37,5x24,5	60	14,3/4x9,5/8	23,5/8	3 (x2)	101 (x2)

**Distributore cereali singolo con base in acciaio**

Single cereal dispenser with stainless steel base

Distributeur céréales individuel avec base en acier Inoxidable

Müslidispenser mit Stahlboden

Dispensador de cereales individual con base de acero Inoxidable

Acciaio Inox 18/10 - St. Steel 18/10

	cm	H. cm	in	H. in	lt	oz
V77 05 52 CD4	31x21	60	12,1/4x8,1/4	23,5/8	3	101

**Cestino portabrioche tondo
con cloche basculante**

Round croissant basket with rolltop cover
Corbeille ronde à viennoiseries avec cloche basculante
Büffetkorb - rund mit Rolltophaube
Cesta de buffet redonda con campana roll top

Rattan - San

	ø cm	ø in	Hcm	H. in
V77 04 52 T44	44	17,3/8	35	13,3/4



**Cestino portabrioche rettangolare
con cloche basculante**

Rattan rectangular croissant basket with rolltop cover
Corbeille rectangulaire à viennoiseries avec cloche basculante
Büffetkorb - rechteckig mit Rolltophaube
Cesta de buffet rectangular con campana roll top

Rattan - San

	cm	in	H. cm	H. in
V77 04 52 R50	50x29,5	19,3/4x11,5/8	29,5	11,5/8



Supporto refrigerato per caraffe succhi con vassoio portabicchieri*

Thermal stand for juice pitchers with glasses tray*
Support réfrigéré pour carafes jus avec plateau porte-verres
Saftkaraffenständer gekühlt mit Gläserständer
Soporte refrigerante para jarras zumo con bandeja para vasos

Acciaio Inox 18/10 - St. Steel 18/10

	ø cm	ø in	H. cm	H. in
V77 05 52 SUC			67	26,3/8
Base	41,5	16,3/8		
Alzata - Holder	38,5	15,1/8		
Sede caraffa - Pitcher seat	16,4	6,1/2		

Supporto refrigerato per caraffe succhi*

Thermal stand for juice* pitchers
Support réfrigéré pour carafes jus
Saftkaraffenständer gekühlt
Soporte refrigerante para jarras zumo

Acciaio Inox 18/10 - St. Steel 18/10

	ø cm	ø in	H. cm	H. in
V77 05 52 SUS			36	14,1/8
Base	41,5	16,3/8		
Sede caraffa - Pitcher seat	16,4	6,1/2		



Disco coprieutettici per supporto refrigerante per caraffe

Plate for thermal stand for juice pitchers (to cover ice packs)
Plaque couvre-blocs réfrigérants pour support réfrigéré pour carafes
Deckel für Kühlelemente zum Karaffenbehälter
Placa cubre acumuladores de frio para soporte refrigerante para jarras

	ø cm	ø in
PRV 1A SU CAD S0	41	16,1/8

*Sono escluse le caraffe in vetro
*Without pitchers

Distributore caffè con rubinetto in metallo

Coffee urn
 Distributeur café
 Kaffeedispenser
 Dispensador de café

Acciaio Inox 18/10 - St. Steel 18/10

	ø cm	ø in	H. cm	H. in	lt	oz
V77 05 52 DCA	21	8,4	54	21,1/4	7	237
V77 05 52 DCA 1	21	8,4	62	24,3/8	10	350



Piastra elettrica per distributore caffè

Heating element for coffee urns
 Plaque électrique pour distributeur de café
 Elektro-Heizelement für Kaffeedispenser
 Plancha eléctrica para dispensadores de café

	ø cm	ø in
V77 05 52 PDC	14	5,1/2



Fornello per scaldavivande/distributore caffè

Burner for chafing dishes-coffee urns
 Porte bruleur pour chafing dish et distributeur café
 Brennstoffhalter für Chafing Dish und Kaffeedispenser
 Contenedor de combustible para chafing dish - dispensadores de café

V77 05 52 FDC

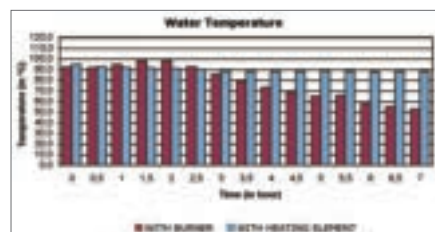

Temperatura ambiente
 External temperature 20,0°

Temperatura acqua
 Water temperature 92,5°/98,8°

Quantità acqua inserita
 Quantity of water added 8 lt

Distributore succhi

Juice dispenser

Distributeur jus

Saftdispenser

Dispensador de zumo

Acciaio Inox 18/10 - St. Steel 18/10

	cm	H	cm lt
V77 05 52 DSM	25x35	66	8
	in	H	in Oz
	9,7/8x13,3/4	26	270

**Contenitore trasparente**

Transparent container

Récipient transparent

Durchsichtbare Behälter

Contenedor transparente

	lt	oz
Z77 63 52 000	8	270

**Euttetici tondi**

Round ice packs

Blocs réfrigérants

Kühlakkus

Acumuladores de frío rectangulares

V77 12 95 T01

Caraffa succhi

Juice pitcher
Carafe jus
Saftkanne
Jarra zumo

Vetro - Glass

	lt	oz
V76 08 52 005	1,5	51
Con coperchio in metallo - with metal lid 18/10		
V76 08 52 009	1,5	51
Senza coperchio - without lid		



Coperchio in acciaio 18/10

Stainless steel lid
Couvercle en acier 18/10
Deckel aus Edelstahl
Tapa de acero Inoxidable

Acciaio Inox 18/10 - St. Steel 18/10

Z76 01 52 005



Caraffa acqua con coperchio basculante

Water glass pitcher with smart lid
Carafe en verre avec couvercle basculant
Wasserkaraffe
Jarra de vidrio con tapa basculante

Vetro - Glass

	lt	oz
V76 08 52 007	1	35
Grigio - Grey		
V76 08 52 007 35	1	35
Avio - Avio		
V76 08 52 007 07	1	35
Rosso - Red		



Caraffa termica 18/10

Thermal beverage serve
Carafe thermos avec anse
Thermische Karaffe
Jarra térmica

Acciaio Inox 18/10 - St. Steel 18/10

	cl	oz
V01 05 08 T06	75	26
V01 05 08 T10	100	35
V01 05 08 T15	150	51
V01 05 08 T20	200	68



**Cavalletto portaetichetta per buffet
(senza tavoletta - without black tag)**

Buffet easel for tags

Chevalet porte-nom pour buffet

Aufsteller Produktinfo

Soporte caballete para etiqueta para buffet

Inox 18/10 - St. Steel

	H. cm	H. in
V01 05 19 001	14,5	5,3/4



Tavoletta nera per cavalletto

Black tag for easel

Plaque pour chevalet noir

Schild für Produktinfo

Etiqueta negra para soporte caballete

Plexiglass

	H. cm	H. in
V01 12 19 001	10x7,5	4x3

Poggiamestolo

Ladle stand

Repose louche

Reposa cucharas

Ständer/Halter Soßenkelle

Inox 18/10 - St. Steel

	ø cm	ø in
V39 05 81 001	11	4,3/8



CAR
RELLI

CARRELLI



Carrello Servire Industrial

Industrial Service trolley
 Industrial Table roulante de service
 Industrial Servierwagen
 Industrial Carro de servicio

● **Legno - Wood**

	Cm	In
V24 18 51 002	90 x 50 h.82	19,3/4 x 35,3/8 h.32,1/4

● **Nero - Black**

	Cm	In
V24 18 51 012	90 x 50 h.82	19,3/4 x 35,3/8 h.32,1/4

**Carrello Servire Industrial con cassetto**

Industrial Service trolley with drawer
 Industrial Table roulante de service avec tiroir
 Industrial Servierwagen, 1 Schublade
 Industrial Carro de servicio con cajón

● **Legno - Wood**

	Cm	In
V24 18 51 003	90 x 50 h.82	19,3/4 x 35,3/8 h.32,1/4

● **Nero - Black**

	Cm	In
V24 18 51 013	90 x 50 h.82	19,3/4 x 35,3/8 h.32,1/4





Top Dolci/Formaggi Industrial

Industrial dessert/cheese top

Dessus à dessert/fromages Industrial

Kompletter Servierwagen für Dessert & Käse

Carro industrial postres/quesos

● Legno - Wood

	Cm	In
V24 18 51 T05	50 x 90 h.28	19,3/4 x 35,3/8 h.11

● Nero - Black

	Cm	In
V24 18 51 T15	50 x 90 h.28	19,3/4 x 35,3/8 h.11





Top Bar Industrial

Industrial bar top

Dessus à bar Industrial

Industrial-Baroberteil

Encimera bar Industrial

● Legno - Wood

	Cm	In
V24 18 51 T01	50 x 90 h.11	19,3/4 x 35,3/8 h.4,3/8

● Nero - Black V24 18 51 T11

	Cm	In
V24 18 51 T11	50 x 90 h.11	19,3/4 x 35,3/8 h.4,3/8



Ripiano pieghevole (1 pezzo) - Carrello Servire Industrial

Folding shelf (1 piece) - Industrial Service trolley

Étagère pliable (1 pièce)- Industrial Table roulante de service

Klappbarem Regal (1 Stück) - Industrial Servierwagen

Estante plegable (1 pieza)- Industrial Carro de servicio

● **Legno - Wood**

	Cm	In
V24 18 51 R01	40 x 40 h.3	19,1/4 x 15,3/4 h.1,1/8

● **Nero - Black**

	Cm	In
V24 18 51 R11	40 x 40 h.3	19,1/4 x 15,3/4 h.1,1/8



Griglia laterale (1 pezzo) - Carrello Servire Industrial

Side grid (1 piece) - Industrial Service trolley

Grille latérale (1 pièce) - Industrial Table roulante de service

Seitengitter (1 Stück)- Industrial Servierwagen

Reja lateral (1 pieza) - Industrial Carro de servicio

	Cm	In
● V24 18 51 G01	48 x 65 h.0,5	19 x 25 h.5/8





Carrello Gueridon Industrial

Industrial gueridon trolley
Chariot Industrial Industrial
Industrial Gueridon-Wagen
Carro Industrial Lineay

● **Legno - Wood**

	Cm	In
V24 18 51 001	35 x 70 h.73	13,3/4 x 27,1/2 h.28,3/4

● **Nero - Black**

	Cm	In
V24 18 51 011	35 x 70 h.73	13,3/4 x 27,1/2 h.28,3/4



Combina i diversi elementi per personalizzare il tuo carrello. Design lineare ed eleganza dal sapore naturale sono i tratti distintivi di questa linea: una proposta di carrelli da comporre a piacimento, mixando gli elementi standard per un servizio unico e su misura.

Combine the different elements to customise your trolley. Linear design and natural elegance are the distinguishing features of this line: a range of trolleys that you can compose as you wish, by mixing the standard elements for a bespoke and unique service.





Carrello Gueridon

Gueridon trolley
Chariot Guéridon
Carro Gueridon
Servierwagen Gueridon

	cm	Colore / Color
 V42 04 51 001	90x50 h.80	Rovere chiaro / Light oak
 V42 04 51 002	90x50 h.80	Rovere scuro / Dark oak



Caratteristiche tecniche:

- Gamba in massello
- Ruota pivotante \varnothing 13 cm
- Piani rivestiti in laminato
- Due ruote con freno



Carrello LUX con due cassetti

LUX trolley, 2-drawer

Chariot LUX avec tiroir

Carro LUX con cajón

Servierwagen LUX, 2 Schubladen

	cm	Colore / Color
 V42 04 51 003	90x50 h.80	Rovere chiaro / Light oak
 V42 04 51 004	90x50 h.80	Rovere scuro / Dark oak

**Technical characteristics:**

- Solid wood stand
- Pivoting wheel, $\varnothing 13$ cm
- Laminate covered tops
- Two wheels with brake

Top dolci / formaggi refrigerato

Dessert/cheese top, refrigerated
 Etagère dessert/fromages réfrigéré
 Bandeja postres/quesos refrigerado
 Dessert/Käse-Top; gekühlt

	cm	Colore / Color
 V42 04 51 T05	90x50 h.28	Rovere chiaro / Light oak
 V42 04 51 T06	90x50 h.28	Rovere scuro / Dark oak

Carrello Gueridon

Gueridon trolley
 Chariot Guéridon
 Carro Gueridon
 Servierwagen Gueridon

	cm	Colore / Color
 V42 04 51 001	90x50 h.80	Rovere chiaro / Light oak
 V42 04 51 002	90x50 h.80	Rovere scuro / Dark oak







Top bar con ringhiera 90x50

Bar top with railing 90x50

Etagère bar a/barrière 90x50

Bandeja bar c/barandilla 90x50

Bar-Top mit Umrandung 90x50

	cm	Colore / Color
 V42 04 51 T03	90x50 h.10,5	Rovere chiaro / Light oak
 V42 04 51 T04	90x50 h.10,5	Rovere scuro / Dark oak



Carrello LUX con due cassetti

LUX trolley, 2-drawer

Chariot LUX avec tiroir

Carro LUX con cajón

Servierwagen LUX, 2 Schubladen

	cm	Colore / Color
 V42 04 51 003	90x50 h.80	Rovere chiaro / Light oak
 V42 04 51 004	90x50 h.80	Rovere scuro / Dark oak

Carrello bar / liquori

Bar/liquor trolley
Chariot bar/liqueurs
Carro bar/licores
Bar/Likör-Wagen

	cm	Colore / Color
 V42 04 51 015	90x50 h.90,5	Rovere chiaro / Light oak
 V42 04 51 016	90x50 h.90,5	Rovere scuro / Dark oak



Carrello dolci / formaggi refrigerato

Dessert/cheese trolley, refrigerated

Chariot dessert/fromages réfrigéré

Carro postres/quesos refrigerado

Dessert/Käse-Wagen; gekühlt

	cm	Colore / Color
 V42 04 51 013	90x50 h.108	Rovere chiaro / Light oak
 V42 04 51 014	90x50 h.108	Rovere scuro / Dark oak



Accessori per foro

Hole accessories

Vasca ghiaccio Acciaio 18/10

Ice pan/champagne bucket 18/10 St.Steel

Bac à glace Acier 18/10

Cubeta de hielo Acero 18/10

Eispanne / Champagnerkühler, Edelstahl 18/10

V42 05 51 006 43x40 h. 16 cm

Scaldavivande GN 2/3

Chafing dish GN 2/3

Chafing dish empotr GN 2/3

Chafing dish empotrable GN 2/3

Chafing-Dish GN 2/3

305 05 52 695 Coperchio in acciaio / St. Steel lid

305 05 52 694 Coperchio in vetro / Glass lid

Piastra a induzione c/supporto inox 18/10

Induction plate + steel counter top 18/10 St.steel

Plaque à induction a/support Acier 18/10

Placa de inducción c/soporte Acero 18/10

Induktionsplatte und Arbeitsplatte, Edelstahl 18/10

V42 05 51 002 84x40,5 h.7 cm

Accessori ad incastro sulle ringhiere

Interlocking accessories on railings

Porta bottiglie / glacette

Bottle/bottle-cooler holder

Porte-bouteilles/glacette

Porta botellas/enfriador botellas

Flaschen-/Flaschenkühlerhalter

V42 05 51 003 46x17 h.1,6 cm

Porta sorbettiere

Sherbet-pot holder

Support sorbetières

Porta sorbeteras

Sorbet-Topf Stand

V42 05 51 004 46x17 h.1,6 cm

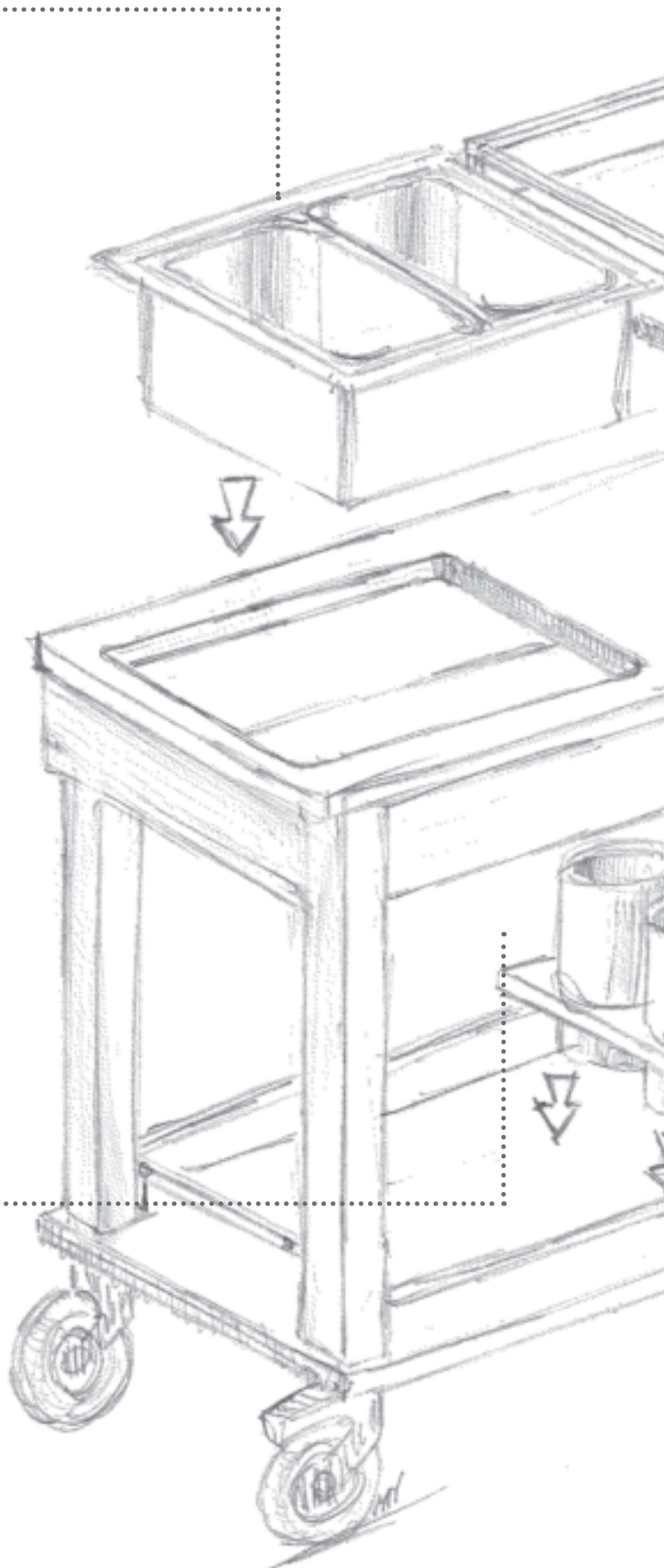

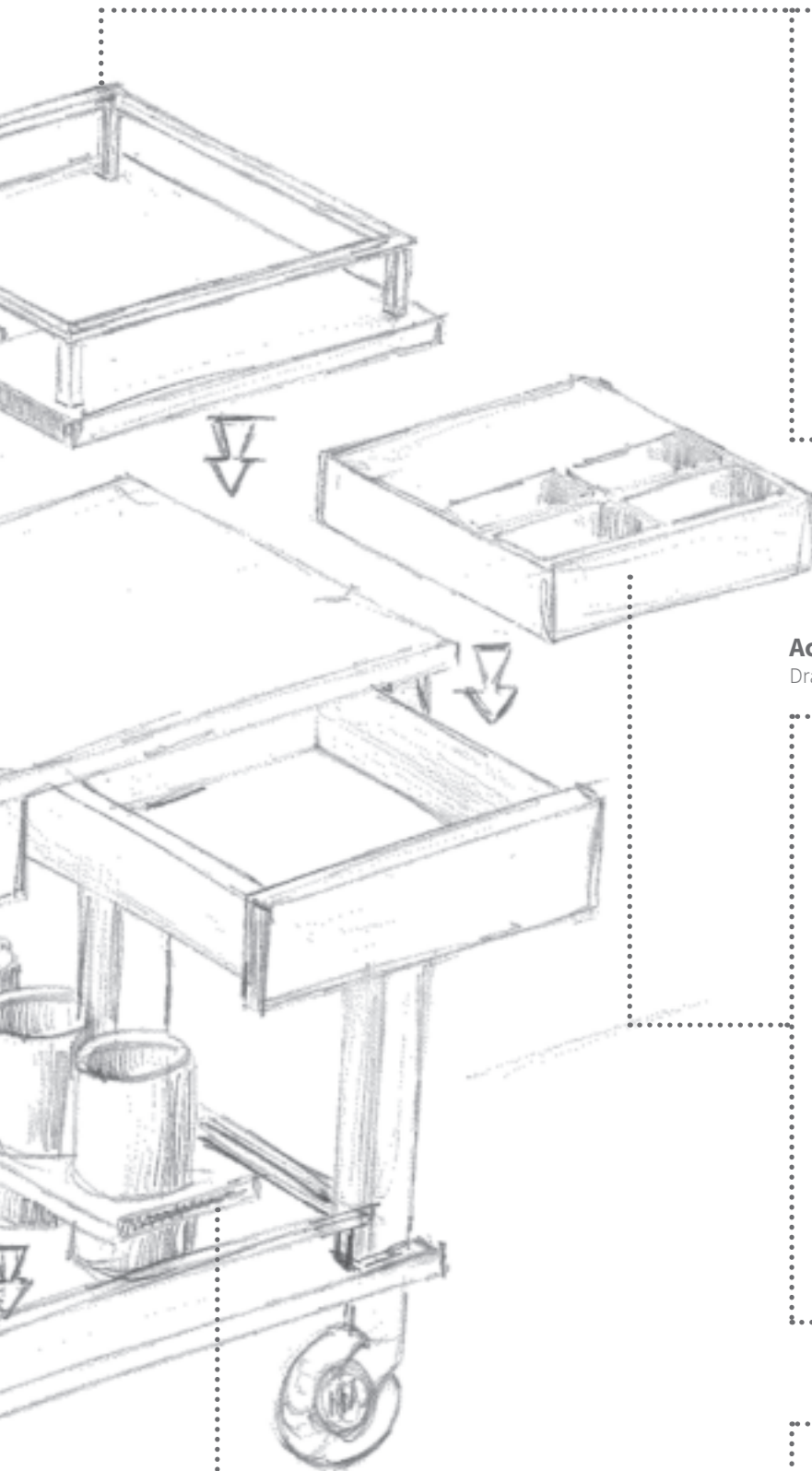

Top bar con ringhiera 41x50

Bar top with railing 41x50

Etagère bar a/barrière 41x50

Bandeja bar con barandilla 41x50

Bar-Top mit Umrandung, 41x50

V42 04 51 T01 41x50 h.10,5 cm

V42 04 51 T02 41x50 h.10,5 cm

Tagliere in legno

Wood cutting board

Planche à découper en bois

Tabla de cortar de madera

Holz Schneidebrett

V42 04 71 001 38x40 h.2 cm

Accessori per cassetto

Drawer accessories

Porta posate

Cutlery-holder insert

Porte-couverts

Porta cubiertos

Besteckhalter-Einsatz

V42 04 94 001 36x29 h.7 cm

Inserto portacondimenti

Condiment-holder insert

Porte-condiments

Porta condimentos

Condimenthalter-Einsatz

V42 05 51 005 36x29 h.7 cm

Compenso poggia piatti

Dish tray

Support à assiettes

Bandeja para platos

Geschirr-Tablett

V42 04 42 001 29,5x25 h. 7 cm

Ringhiera porta accessori

Accessory-holder railing

Barrière porte-accessoires

Barandilla porta accesorios

Accessoires-Halter mit Umrandung

V42 05 51 001 46x86 h.8 cm

Carrello cocktail

Cocktail trolley
Chariot à cocktail
Carro cocktail
Cocktail-Wagen

	cm	Colore / Color
 V42 04 51 011	90x50 h.90,5	Rovere chiaro / Light oak
 V42 04 51 012	90x50 h.90,5	Rovere scuro / Dark oak



Carrello arrosti

Roast-beef trolley
Chariot boeuf
Carro carne asada
Roastbeef-Wagen

	cm	Colore / Color
 V42 04 51 009	90x50 h.90	Rovere chiaro / Light oak
 V42 04 51 010	90x50 h.90	Rovere scuro / Dark oak



Carrello Flambé ad induzione

Flambé trolley - induction

Chariot a flambé induction

Carro para flameado de inducción

Flambéwagen, Induktion

	cm	Colore / Color
 V42 04 51 007	90x50 h.80	Rovere chiaro / Light oak
 V42 04 51 008	90x50 h.80	Rovere scuro / Dark oak





Carrello LUX multiuso

Universal trolley LUX

Chariot LUX multi-usages

Carro LUX multiuso

Servierwagen LUX

	cm	Colore / Color
 V42 04 51 005	90x50 h.80	Rovere chiaro / Light oak
 V42 04 51 006	90x50 h.80	Rovere scuro / Dark oak



Top bar con ringhiera 90x50

Bar top with railing 90x50

Etagère bar a/barrière 90x50

Bandeja bar c/barandilla 90x50

Bar-Top mit Umrandung 90x50

	cm	Colore / Color
 V42 04 51 T03	90x50 h.10,5	Rovere chiaro / Light oak
 V42 04 51 T04	90x50 h.10,5	Rovere scuro / Dark oak



**Top dolci / formaggi refrigerato**

Dessert/cheese top, refrigerated

Etagère dessert/fromages réfrigéré

Bandeja postres/quesos refrigerado

Dessert/Käse-Top; gekühlt

	cm	Colore / Color
 V42 04 51 T05	90x50 h.28	Rovere chiaro / Light oak
 V42 04 51 T06	90x50 h.28	Rovere scuro / Dark oak

**Ringhiera porta accessori**

Accessory-holder railing

Barrière porte-accessoires

Barandilla porta accesorios

Accessoires-Halter mit Umrandung

Inox 18/10 - St. Steel

	cm
V42 05 51 001	46x86 h.8



Piastra a induzione c/supporto inox 18/10

Induction plate + steel counter top 18/10 St. steel
 Plaque à induction a/support Acier 18/10
 Placa de inducción c/soporte Acero 18/10
 Induktionsplatte und Arbeitsplatte, Edelstahl 18/10

cm
V42 05 51 002 84x40,5 h.7

**Vasca ghiaccio Acciaio 18/10**

Ice pan/champagne bucket 18/10 St. Steel
 Bac à glace Acier 18/10
 Cubeta de hielo Acero 18/10
 Eispfanne / Champagnerkühler, Edelstahl 18/10

Inox 18/10 - St. Steel



Contenitore in acciaio per GN **V42 05 51 006** **43x40 h. 16**
 Steel container for GN

Compatibile con
 Compatible with

1 x GN 2/3	V01 05 72 G23D V01 05 15 G23	h. 15 cm coperchio / lid
1 x GN 1/3	V01 05 72 G13D V01 05 15 G13	h. 15 cm coperchio / lid

**Top bar con ringhiera 41x50**

Bar top with railing 41x50
 Etagère bar a/barrière 41x50
 Bandeja bar con barandilla 41x50
 Bar-Top mit Umrandung, 41x50

cm Colore / Color
V42 04 51 T02 41x50 h.10,5 **Rovere scuro / Dark oak**



Scaldavivande GN 2/3

Chafing dish GN 2/3

Chafing dish empotr GN 2/3

Chafing dish empotrable GN 2/3

Chafing-Dish GN 2/3

Inox 18/10 - St. Steel

	cm	H. cm	
305 05 52 695	43 x 40	21	Coperchio in acciaio / St. Steel lid
305 05 52 694	43 x 40	21	Coperchio in vetro / Glass lid

**Fornelletto per scaldavivande**

Chafing-dish burner

Porte-brûleur pour chafing dish

Brennstoffhalter für Chafing Dish

Contenedor de combustible para chafing dish

V77 05 52 FDC

**Piastra elettrica**

Electric hot plate

Plaque électrique

Elektrische Platte

Placa eléctrica

Con regolatore - With regulator

V770552PCR2

Piastra elettrica con regolatore per scaldavivande 1/1 V230

**Tagliere in legno**

Wood cutting board

Planche à découper en bois

Tabla de cortar de madera

Holz Schneidebrett

Legno multistrato - Multi-layer wood

	cm
V42 04 71 001	38x40 h.2



Porta bottiglie / glacette

Bottle/bottle-cooler holder
 Porte-bouteilles/glacette
 Porta botellas/enfriador botellas
 Flaschen-/Flaschenkühlerhalter

Inox 18/10 - St. Steel

V42 05 51 003 cm
 46x17 h.1,6

Compatibile con

Compatible with
 3 Glacette

1 x Glacette
 Bottle coolers

V78 05 24 01 01 401

ø12 h.17 cm

**Porta sorbettiere**

Sherbet-pot holder
 Support sorbetières
 Porta sorbeteras
 Sorbet-Topf Stand

Inox 18/10 - St. Steel

V42 05 51 004 cm
 46x17 h.1,6

Compatibile con

Compatible with
 2 Sorbettiere

1 x Sorbettierra
 Ice bucket

V78 05 20 00 11 401

ø15 h.19,5 cm



Porta posate

Cutlery-holder insert
 Porte-couverts
 Porta cubiertos
 Besteckhalter-Einsatz

Legno multistrato - Multilayer wood

cm
 V42 04 94 001 36x29 h.7

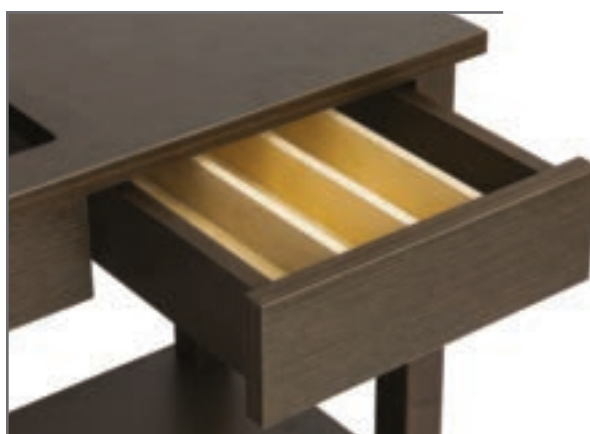

Inserto portaccondimenti

Condiment-holder insert
 Porte-condiments
 Porta condimentos
 Cordimenthalter-Einsatz

Inox 18/10 / 18/10 st. steel - ABS

cm
 V42 05 51 005 36x29 h.7



Compenso poggia piatti

Dish tray
 Support à assiettes
 Bandeja para platos
 Geschirr-Tablett

Legno multistrato - Multilayer wood

cm
 V42 04 42 001 29,5x25 h. 7



Cassetto estraibile con chiusura ammortizzata

Pull-out drawer with cushioned closing
 Tiroir amovible avec fermeture en douceur
 Cajón extraíble con cierre suave
 Ausziehschublade mit sanftem Verschluss



Gamba in legno massello e piani rivestiti in laminato

Solid wood stand and tops, covered in laminate
 Support en bois massif et étagères revêtues en laminé
 Soporte de madera maciza y niveles revestidos en laminado
 Massivholzständer und -platten mit Laminat bezogen



Ruota pivotante antistatica con freno ø 13 cm

Anti-static pivoting wheel with brake, ø 13 cm
 Roue pivotante antistatique avec frein ø 13 cm
 Rueda pivotante antiestática con freno ø 13 cm
 Antistatisches Schwenkrad mit Bremse, ø 13 cm



Carrello Basic

Basic trolley
Chariot Basic
Carro Basic
Basic-Wagen

■	Rovere scuro / Dark oak	cm
V43 04 51 002		80x50 h.80
V43 04 51 004		70x35 h.80



Caratteristiche tecniche:

- Gamba in acciaio inox 18/10
- Ruota pivotante ø13 cm
- Piani rivestiti in laminato
- Due ruote con freno

Technical characteristics:

- 18/10 stainless steel stand
- Pivoting wheel, ø13 cm
- Laminate covered tops
- Two wheels with brake



Top bar con ringhiera

Bar top with railing
Etagère bar a/barrière
Bandeja bar c/barandilla
Bar-Top mit Umrandung

	Cm	Colore / Color
■ V43 04 51 T02	80x50 h. 7,3	Rovere scuro / Dark oak



Carrello Basic

Basic trolley
 Chariot Basic
 Carro Basic
 Basic-Wagen

	Rovere chiaro / Light oak	cm
V43 04 51 001		80x50 h.80
V43 04 51 003		70x35 h.80

**Top bar con ringhiera**

Bar top with railing
 Etagère bar a/barrière
 Bandeja bar c/barandilla
 Bar-Top mit Umrandung

	Cm	Colore / Color
 V43 04 51 T01	80x50 h. 7,3	Rovere chiaro / Light oak
 V43 04 51 T02	80x50 h. 7,3	Rovere scuro / Dark oak



Pliant pieghevole in legno

Folding support for trays, wood
 Support pliant en bois pour plateaux
 Soporte plegable de madera para bandejas
 Faltbarer Tablettständer, Holz

	H. cm
319 04 23 882	70
319 04 23 892	85



4 guarnizioni
 antiscivolo
 4 non-slip
 gaskets

Vassoio room-service in legno

Room Service Tray, wood
 Plateau room-service en bois
 Bandeja room-service de madera
 Room-Service Tablett, Holz

	cm
V42 04 23 001	60x39,5

**Coprivassoio in Plexiglass**

Acrylic tray cover
 Cloche acrylique pour plateau carré
 Cúpula acrílica para bandeja
 Acryl Room-Service Tablett

	cm
V01 12 15 001	56x35 h18



CUCINA

CUCINA

Padella 1 manico

Frying pan, 1-handle
Poêle avec 1 manches
Sartén un mangos
Mit Griff Pfanne

Alluminio con fondo a induzione
Aluminium with induction bottom

	ø cm	ø in	H. cm	H. in
V67 11 72 PA24	24	9,1/2	6	2,3/8
V67 11 72 PA28	28	11	7	2,3/4
V67 11 72 PA32	32	12,5/8	7,5	3
V67 11 72 PA36	36	14,1/8	8	3,1/8
V67 11 72 PA40	40	15,3/4	8,5	3,3/8

**Pentola 2 manici**

Pot, 2-handle
Casserole avec 2 manches
Olla dos mangos
Mit 2 Griffen Topf

Alluminio con fondo a induzione
Aluminium with induction bottom

	ø cm	ø in	H. cm	H. in	lt
V67 11 72 PE28	28	11	15	6	8
V67 11 72 PE32	32	2,5/8	15	6	12

**Casseruola 2 manici**

Casserole, 2-handle
Casserole à 2 manches
Cacerola 2 mangos
Kasserolle mit 2 Griffen

Alluminio con fondo a induzione
Aluminium with induction bottom

	ø cm	ø in	H. cm	H. in	lt
V67 11 72 CA32	32	12,5/8	11,5	4,1/2	9

**Tegame 2 manici**

Frying pan, 2-handle
Poêlon avec 2 manches
Olla dos mangos
Mit 2 Griffen Flache Kochtopf

Alluminio con fondo a induzione
Aluminium with induction bottom

	ø cm	ø in	H. cm	H. in
V67 11 72 TE24	24	9,1/2	6	2,3/8
V67 11 72 TE28	28	11	7	2,3/4
V67 11 72 TE32	32	12,5/8	7,5	3
V67 11 72 TE36	36	14,1/8	8	3,1/8
V67 11 72 TE40	40	15,3/4	8,5	3,3/8





COOK & SERVE

Il nuovo tegame Cook & Serve è una soluzione comoda e pratica. Ideale per la cottura degli alimenti grazie al fondo di 2mm e alla conducibilità dell'alluminio, che permette una diffusione uniforme del calore sull'intera superficie. Leggero, maneggevole ed elegante, diventa un accessorio perfetto anche per il servizio in tavola.

COOK & SERVE

The new pan Cook & Serve is a convenient and practical solution.

Ideal for cooking food, thanks to its 2-mm bottom and to aluminum conductivity, that allows a uniform heat diffusion on the whole surface.

Light, easy to handle and elegant, it becomes the perfect tool for the table service as well.



Tegame 2 manici

Saucepan, 2-handle

Faitout 2 anses

Sartén 2 asas

Topf, 2 Griffe

Alluminio / Aluminum

	∅ cm	H. cm
V67 11 72 TP 16	16	4,5
V67 11 72 TP 18	18	4,5
V67 11 72 TP 20	20	4,5
V67 11 72 TP 22	22	4,5
V67 11 72 TP 24	24	4,5

Wok antiaderente

Wok, non-stick
 Wok anti-adhésif
 Wok antiadherente
 Wok mit einem Griff

Alluminio con fondo a induzione
Aluminium with induction bottom

	ø cm	ø in	H.	Hin
V68 11 72 WO 26	26	10,1/4	7,8	3
V68 11 72 WO 28	28	11	7,8	3
V68 11 72 WO 30	30	11,3/4	8,8	3,1/2



Casseruola 2 manici

Casserole, 2-handle
 Casserole à 2 manches
 Cacerola 2 mangos
 Kasserolle mit 2 Griffen

Alluminio con fondo a induzione
Aluminium with induction bottom

	ø cm	ø in	H. cm	H. in	lt
V68 11 72 CA 20A	20	7,7/8	8,8	3,1/2	2,8
V68 11 72 CA 22	22	8,5/8	9,2	3,1/2	3,5
V68 11 72 CA 24	24	9,1/2	10,7	4,1/8	4,8
V68 11 72 CA 26	26	10,1/4	11,8	4,3/4	6,2
V68 11 72 CA 28	28	11	11,5	4,3/4	4,1/2
V68 11 72 CA 32	32	12,5/8	12	4,3/4	9,5



cm	H. in	lt
2,3/4	1	
3,1/8	1,6	
3,1/2	2,2	
3,1/2	2,8	



Padella antiaderente 1 manico

Frying pan, non-stick 1-handle

Poêle antiadhérente avec 1 manches

Sartén antiadherente un mangos

Mit Griff Pfanne

Alluminio con fondo a induzione**Aluminium with induction bottom**

	ø cm	ø in	H. cm	H. in
V68 11 72 PA20	20	7,7/8	4,3	1,3/4
V68 11 72 PA22	22	8,5/8	4,3	1,3/4
V68 11 72 PA24	24	9,1/2	6	2,3/8
V68 11 72 PA28	28	11	7	2,3/4
V68 11 72 PA32	32	12,5/8	7,5	3
V68 11 72 PA36	36	14,1/8	8	3,1/8
V68 11 72 PA40	40	15,3/4	8,5	3,3/8

**Pentola antiaderente 2 manici**

Pot, non-stick 2-handle

Casserole antiadhérente avec 2 manches

Olla antiadherente dos mangos

Mit 2 Griffen Topf

Alluminio con fondo a induzione**Aluminium with induction bottom**

	ø cm	ø in	H. cm	H. in	lt
V68 11 72 PE24	24	9,1/2	14	5,1/2	6,3
V68 11 72 PE28	28	11	15	6	8
V68 11 72 PE32	32	12,5/8	14,5	5,3/4	11,6

**Tegame antiaderente 2 manici**

Pot, non stick 2 - handle

Casserole antiadhérente avec 2 manches

Olla antiadherente dos mangos

Mit 2 Griffen Flache Kochtopf

Alluminio con fondo a induzione**Aluminium with induction bottom**

	ø cm	ø in	H. cm	H. in
V68 11 72 TE24	24	9,1/2	6	2,3/8
V68 11 72 TE28	28	11	7	2,3/4
V68 11 72 TE32	32	12,5/8	7,5	3
V68 11 72 TE36	36	14,1/8	8	3,1/8
V68 11 72 TE40	40	15,3/4	8,5	3,3/8



Mestolo

Ladle
Louche
Cazo
Suppenlöffel

Nylon PA 6,6 FG 10%

	cm	in
903 12 81 C15 ME 32	12,5/8	

**Schiumarola**

Skimmer
Ecumoire
Espumadera
Schaumlöffel

Nylon PA 6,6 FG 10%

	cm	in
903 12 81 C15 SC 35	13,3/4	

**Pala fritto**

Frying shovel
Pelle à friture
Pala para freir
Schaufel

Nylon PA 6,6 FG 10%

	cm	in
903 12 81 C15 FR 35	13,3/4	

**Paletta**

Showel
Pelle
Pala
Schaufel

Nylon PA 6,6 FG 10%

	cm	in
903 12 81 C15 PA1 35	13,3/4	

**Cucchiaine forato**

Slotted spoon
Cuillère à servir perforée
Cucharón perforado
Gelochte Servierlöffel

Nylon PA 6,6 FG 10%

	cm	in
903 12 81 C15 CUF 35	13,3/4	

**Cucchiaine**

Serving spoon
Cuillère à servir
Cucharón
Servierlöffel

Nylon PA 6,6 FG 10%

	cm	in
903 12 81 C15 CU 35	13,3/4	

**Servispaghetti**

Spaghetti serving spoon
Louche à spaghetti
Cucharón para spaghetti
Servierlöffel für Spaghetti

Nylon PA 6,6 FG 10%

	cm	in
903 12 81 C15 SP 33,4	13,1/4	

**Paletta**

Showel
Pelle
Pala
Schaufel

Nylon PA 6,6 FG 10%

	cm	in
903 12 81 C15 PA2 32	12,5/8	



Paletta forata

Perforated shovel
Pelle perferée
Pala perforada
Gelochte Schaufel

Nylon PA 6,6 FG 10%

	cm	in
903 12 81 C15 PAF 31,5	12,3/8	

**Paletta fritto**

Frying shovel
Pelle à friture
Pala para freir
Schaufel

Nylon PA 6,6 FG 10%

	cm	in
903 12 81 C15 PAA 32	12,5/8	

**Pinza chef**

Chef tongs
Pince chef
Pinzas de chef
Chef Zange

Nylon PA 6,6 FG 10%

	cm	in
903 12 81 C15 PI	30,5	12

**Paletta scolatutto**

Draining spoon
Cuillère à égoutter
Cuchara para colar
Schaumschaufel

Nylon PA 6,6 FG 10%

	cm	in
903 12 81 C15 PFG 38	15	

**Molla toast/dolce**

Toast/cake tongs
Pince à gâteaux
Pinzas postre
Kuchenschaufel

Nylon PA 6,6 FG 10%

	cm	in
903 12 81 C15 MD 28	11	

**Molla insalata**

Salad tongs
Pince à salade
Pinzas ensalad
Salatschaufel

Nylon PA 6,6 FG 10%

	cm	in
903 12 81 C15 MI 31	12,1/4	

**Molla spaghetti**

Spaghetti tongs
Pince à spaghetti
Pinzas spaghetti
Spaghetizange

Nylon PA 6,6 FG 10%

	cm	in
903 12 81 C15 MS 31	11	

**Molla arrosto**

Roast tongs
Pince à rôti
Pinzas asado
Braten/Fleischzange

Nylon PA 6,6 FG 10%

	cm	in
903 12 81 C15 MA 31	11	



Coltello chef

Chef knife
Couteau chef
Cuchillo cocinero
Chefmesser

Acciaio Inox - St. Steel + ABS

	cm lama	in blade
V67 06 91 001	15	6
V67 06 91 002	20	7,7/8
V67 06 91 025	23	9
V67 06 91 026	25	9,7/8

**Coltello pane**

Bread knife
Couteau pain
Cuchillo pan
Brottmesser

Acciaio Inox - St. Steel + ABS

	cm lama	in blade
V67 06 91 003	20	7,7/8

**Coltello affettare**

Slicing knife
Couteau pour coupe en tranches
Cuchillo para filetear
Messer zum Aufschneiden

Acciaio Inox - St. Steel + ABS

	cm lama	in blade
V67 06 91 004	20	7,7/8

**Coltello utility**

Utility knife
Couteau de service
Cuchillo universal
Utility-Messer

Acciaio Inox - St. Steel + ABS

	cm lama	in blade
V67 06 91 009	14	5,1/2

**Coltello santoku**

Santoku knife
Couteau Santoku
Cuchillo Santoku
Santoku Profimesser

Acciaio Inox - St. Steel + ABS

	cm lama	in blade
V67 06 91 005	12,5	5
V67 06 91 006	18	7

**Coltello disossare**

Boning knife
Couteau à désosser
Cuchillo deshuesador
Messer zum Entbeinen

Acciaio Inox - St. Steel + ABS

	cm lama	in blade
V67 06 91 007	16	6,1/4



Manaretta

Cleaver
Couperet
Cuchillo de carnicero
Hackbeil Messer

Acciaio Inox - St. Steel + ABS

	cm lama	in blade
V67 06 91 027	18	7

**Affilacoltelli professionale**

Professional sharpener
Aiguiseur à couteaux
Afilador de cuchillos
Schleifmittel

Acciaio Inox - St. Steel + ABS

	cm lama	in blade
V67 06 91 012	20	7,7/8

**Coltello professionale Utility**

Professional Utility knife
Couteau de service dentelé
Cuchillo universal dentado
Utility-Messer

Acciaio Inox - St. Steel + ABS

	cm lama	in blade
V67 06 91 008	11,5	4,1/2

**Coltello spelucchino**

Paring knife
Couteau à éplucher
Cuchillo guarnecer
Schälmesser

Acciaio Inox - St. Steel + ABS

	cm lama	in blade
V67 06 91 010	8,8	3,1/2

**Coltello professionale frutta**

Professional fruit knife
Couteau à fruits
Cuchillo frutas
Obstmesser

Acciaio Inox - St. Steel + ABS

	cm lama	in blade
V67 06 91 011	8,8	3,1/2

**Trinciapollo**

Poultry shears
Ciseaux à volaille
Geflügelschere
cuchillo afilado

Acciaio Inox - St. Steel + ABS

	cm lama	in blade
AVA RI 110	25,5	10



Ciotola

Bowl
Bol
Bol
Schale

Acciaio Inox - St. Steel

	ø cm	ø in	lt
AVARI 049	12	4,3/4	0,5
AVARI 052	16	6,1/4	1
AVARI 050	20	7,7/8	2
AVARI 053	23	9,8/8	3
AVARI 051	26	10,1/4	4
AVARI 054	29	11,1/2	5,5

**Ciotola Daily Plus**

Bowl Daily Plus
Bol Daily Plus
Bol Daily Plus
Schale Daily Plus

Acciaio Inox - St. Steel

	ø cm	ø in	lt
V59 06 43 013	13	5,1/8	0,6
V59 06 43 015	15	5,7/8	0,9
V59 06 43 020	20	7,7/8	2
V59 06 43 023	23,5	9,1/4	2,8
V59 06 43 026	26	10,1/4	3,5

**Lasagnera**

Lasagna tray
Plat á four
Lasañera
Lasagnepfanne

Acciaio Inox - St. Steel

	cm	in
V03 06 26 026	26,5x19,5	10,3/8x7,5/8
V03 06 26 031	31,5x24	12,3/8x9,1/2
V03 06 26 037	37x27	14,1/2x10,5/8
V03 06 26 040	42x30,5	16,1/2x12





Certificato

La SQS attesta che l'organizzazione di seguito indicata dispone di un sistema di gestione conforme ai requisiti della base normativa menzionata.



Abert S.p.A.
Via Don P. Mazzolari, 17 (Zona Industriale)
25050 Passirano (BS)
Italia

Ulteriori siti riportati in appendice

Campo di applicazione

Divisione Abert
Sito di Via Don P. Mazzolari, 17, 25050 Passirano (BS)

Progettazione, fabbricazione e commercializzazione di posate, complementi per la tavola, vasellame, caffettiere e pentolame.

Base normativa

ISO 9001:2015 Sistema di gestione per la qualità

No. di reg. H30537

Validità 13.11.2019 - 10.11.2022
Emissione 13.11.2019

A. Girard
A. Girard, Presidente SQS

F. Müller
F. Müller, CEO SQS



Associazione Svizzera per Sistemi di Qualità e di Management (SQS)
Bernostrasse 103, 3052 Zollikofen, Svizzera



Partner of
IQNet



THE INTERNATIONAL CERTIFICATION NETWORK

CERTIFICATE

SQS has issued an IQNet recognized certificate that the organization:

Abert S.p.A.
Via Don P. Mazzolari, 17 (Zona Industriale)
25050 Passirano (BS)
Italy

has implemented and maintains a
Management System

for the following scope:

Further sites according to appendix SQS

which fulfills the requirements of the following standard(s):

ISO 9001:2015

Issued on: 2019-11-13

Expires on: 2022-11-10

This attestation is directly linked to the IQNet Partner's original certificate and shall not be used as a stand-alone document

Registration Number: CH - H30537



Alex Stoichitoiu
Alex Stoichitoiu
President of IQNet

F. Müller
Felix Müller
CEO SQS



IQNet Partners*
AENOR Spain APNOR Certification France APCER Portugal CCC Cyprus CIBQ Italy
CQC China CQM China CQS Czech Republic Cst Cert Centre DQS Holding GmbH Germany EMAS Certification Group USA
FCM Brazil FONDORAMA Venezuela KONTEC Colombia Ingenera Seritissimi Oy Finland INTECO China Hira
IRAM Argentina JQA Japan KQI Korea METEC Greece ABET Hungary NENAS AS Norway NIAI Ireland
NYCE-SICE Mexico PCR Poland Quality Asserta Austria RR Russia SII Israel SIQ Slovenia
SIRIM QAS International Malaysia SQS Switzerland SRAQ Romania TEST St Petersburg Russia TSE Turkey VUQS Serbia

* The list of IQNet partners is valid at the time of issue of this certificate. Updated information is available under www.iqnet-certification.com

abert

www.abert.it